

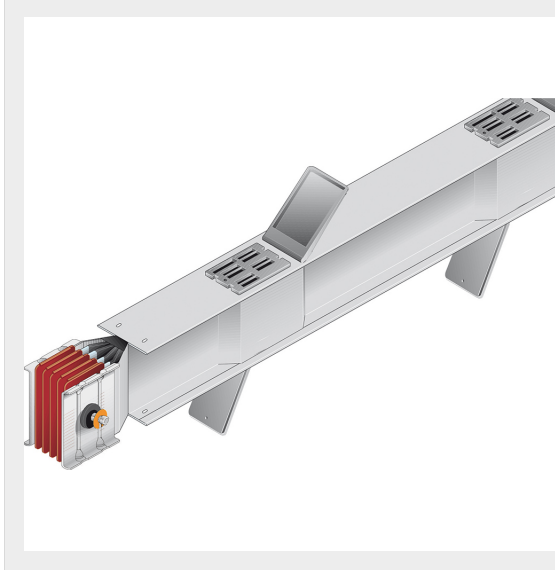

BTICINO > ZUCCHINI busbar > SCP Supercompact > Straight distribution elements



65390976P

Straight element for energy distribution SCP Cu - length 1-1,5m -
In= 4000A - double bar

Technical features

Protection index	IP55
Length	1-1.5m
Standard reference	CEI EN 61439-6
N° of compartments	1+1
Rated voltage	1000V
Rated current	4000A
Series	SCP

Documentation

 [Busbar catalogue](#)