

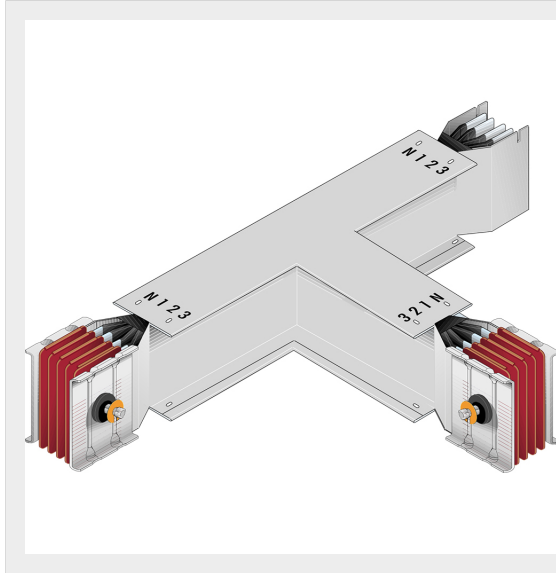

BTICINO > ZUCCHINI busbar > SCP Supercompact > Horizontal T-elements



65390715P

Horizontal T element SCP - Type 2 Cu - In= 3200A - double bar

Technical features

Protection index	IP55
Standard reference	CEI EN 61439-6
Rated voltage	1000V
Rated current	3200A
Series	SCP

Documentation

 [Busbar catalogue](#)