

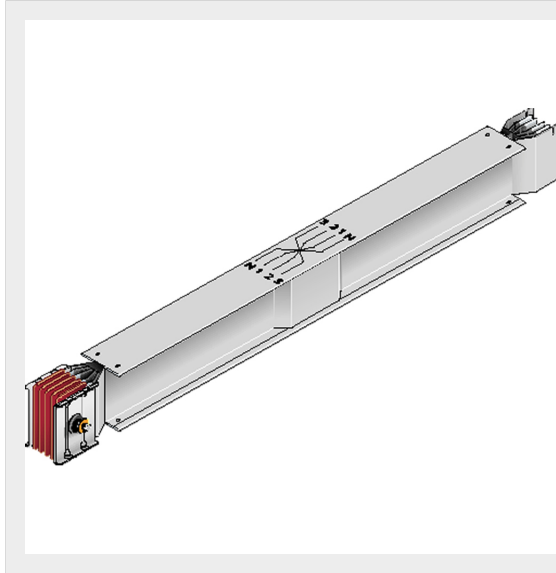

BTICINO > ZUCCHINI busbar > SCP Supercompact > Phase inversion straight elements



65287128P

Transposition straight element SCP Cu - In= 2500A

Technical features

Protection index	IP55
Standard reference	CEI EN 61439-6
Rated voltage	1000V
Rated current	2500A
Series	SCP

Documentation

 [Busbar catalogue](#)