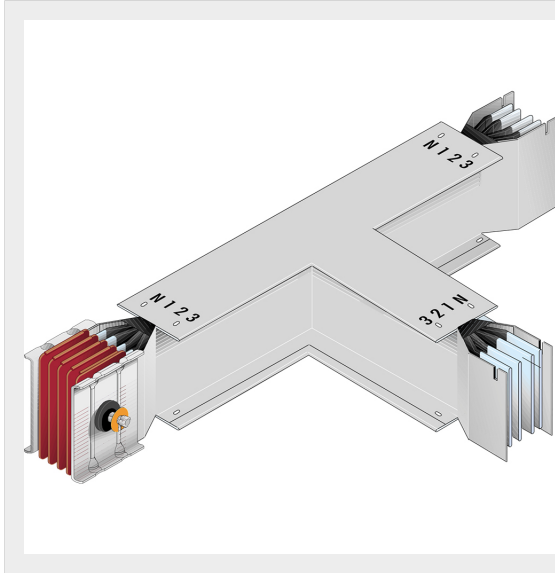

BTICINO > ZUCCHINI busbar > High power busbar > SCP Supercompact > Horizontal T-elements

**65280705P**

Horizontal T element SCP - Type 1 Cu - In= 1600A

Technical features

Brand	BTicino
Standard reference	CEI EN 61439-6
Rated voltage	1000Vac
Rated current	1600A
Protection index	IP55
Series	SCP

Documentation

 [Busbar catalogue](#)