

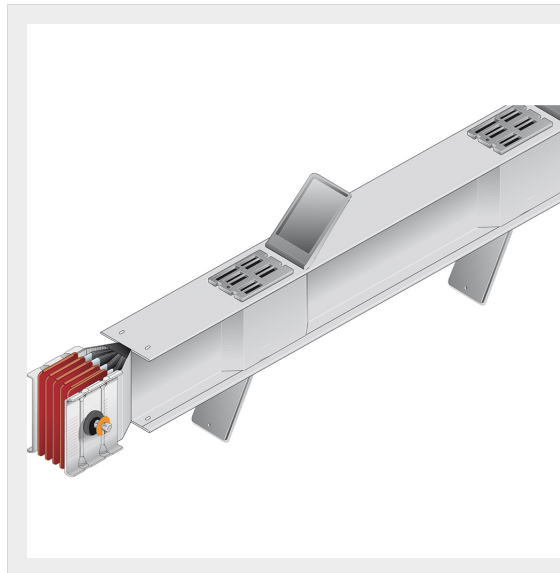

BTICINO > ZUCCHINI busbar > SCP Supercompact > Straight distribution elements



65280130P

Straight element for energy distribution SCP Cu - length 3m - In=800A

Technical features

Protection index	IP55
Length	3m
Standard reference	CEI EN 61439-6
N° of compartments	3+3
Rated voltage	1000V
Rated current	800A
Series	SCP

Documentation

 [Busbar catalogue](#)