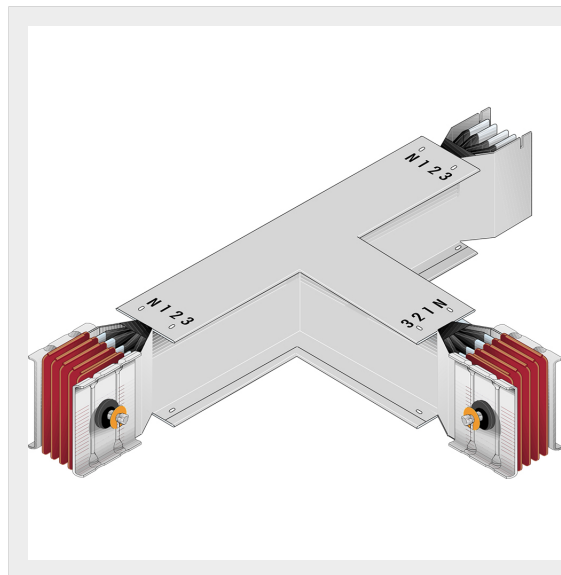

BTICINO > ZUCCHINI busbar > High power busbar > SCP Supercompact > Horizontal T-elements

**60390714P**

Horizontal T element SCP - Type 2 Al - In= 2500A - double bar

Technical features

Brand	BTicino
Standard reference	CEI EN 61439-6
Rated voltage	1000Vac
Rated current	2500A
Protection index	IP55
Series	SCP

Documentation

 [Busbar catalogue](#)