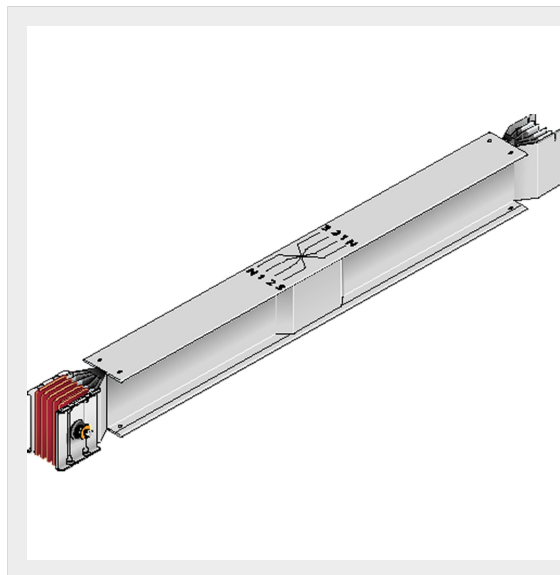

BTICINO > ZUCCHINI busbar > High power busbar > SCP Supercompact > Phase inversion straight elements

**60287126P**

Transposition straight element SCP AI - In= 1600A

Technical features

Brand	BTicino
Standard reference	CEI EN 61439-6
Rated voltage	1000Va.c.
Rated current	1600A
Protection index	IP55
Series	SCP

Documentation

 [Busbar catalogue](#)