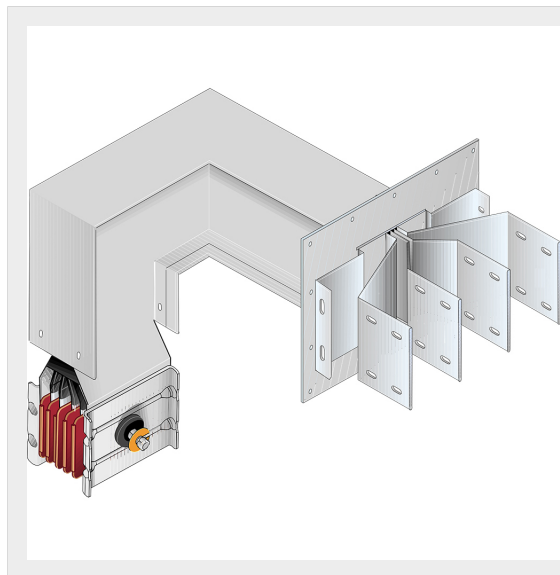

BTICINO > ZUCCHINI busbar > High power busbar > SCP Supercompact > Connection interface with horizontal + vertical elbow

**60281664P**

Busbar outlet element with horizontal + vertical elbow for busbar SCP - Type 7 AI - In= 1250A

Technical features

Brand	BTicino
Standard reference	CEI EN 61439-6
Rated voltage	1000V
Rated current	1250A
Protection index	IP55
Series	SCP

Documentation

 [Busbar catalogue](#)