

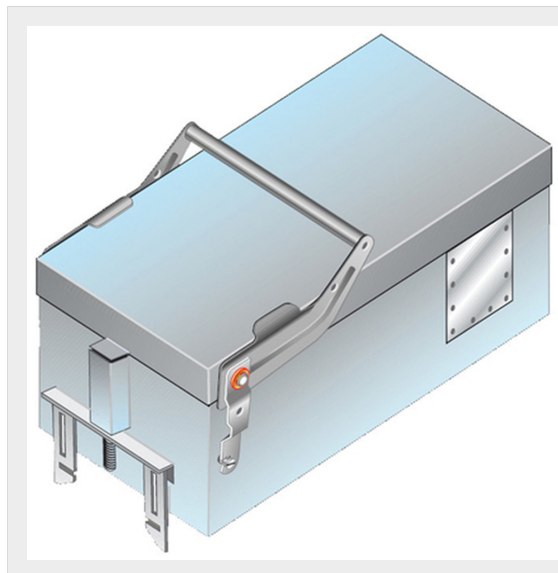

BTICINO > ZUCCHINI busbar > Medium power busbar > MR Medium Rating > Junctions

**50414025**Metallic tap-off box for MR with fuse carrier base NH3 - In=630A
- IP55

Technical features

Brand	BTicino
Standard reference	CEI EN 61439-6
Rated voltage	1000Va.c.
Rated current	630A
Protection index	IP55
Series	MR

Documentation

 [Instruction Sheet](#) [Busbar catalogue](#)