

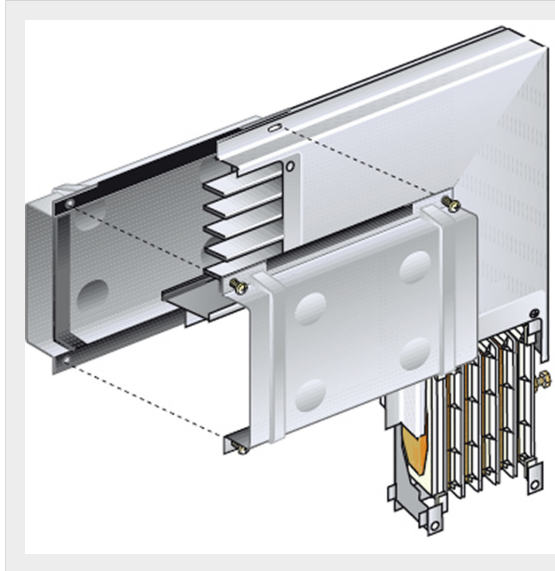

BTICINO > ZUCCHINI busbar > MR Medium Rating > Vertical elbows aluminium



50400418

Vertical elbow (left) in Al for MR500 - In=500A - IP55

Technical features











Protection index	IP55
Standard reference	CEI EN 61439-6
Rated voltage	1000V
Rated current	500A
Series	MR

Documentation

 [Instructions Sheet](#)

 [Busbar catalogue](#)

Related products

 <p>50400268-2400</p> <p>Data Center straight elements (IP40). Aluminium conductors and windows on both sides (4+4, step 600m...</p>	 <p>50400268-1200</p> <p>Data Center straight elements (IP40). Aluminium conductors and windows on both sides (2+2, step 600m...</p>	 <p>50400278-2400</p> <p>Data Center straight elements (IP40). Aluminium conductors and windows on both sides (3+3, step 800m...</p>	 <p>50400278-1600</p> <p>Data Center straight elements (IP40). Aluminium conductors and windows on both sides (2+2, step 800m...</p>	 <p>50400268</p> <p>Data Center straight elements (IP40). Aluminium conductors and windows on both sides (5+5, step 600m...</p>
 <p>50400258</p> <p>Straight element MR500 AI with 5 outlets on one side only - In=500A - IP52 - length 3m</p>	 <p>50400108</p> <p>Straight element MR500 AI with 3+3 outlets for side - In=500A - IP52 - length 3m</p>	 <p>50400128</p> <p>Straight element MR500 AI without outlets - In=500A - IP52 - length 1-1.5m</p>	 <p>50400158</p> <p>Straight element MR500 AI with 2+2 outlets for side - In=500A - IP52 - length 1.5-3m</p>	 <p>50400118</p> <p>Straight element MR500 AI without outlets - In=500A - IP52 - length 0.6-1m</p>