

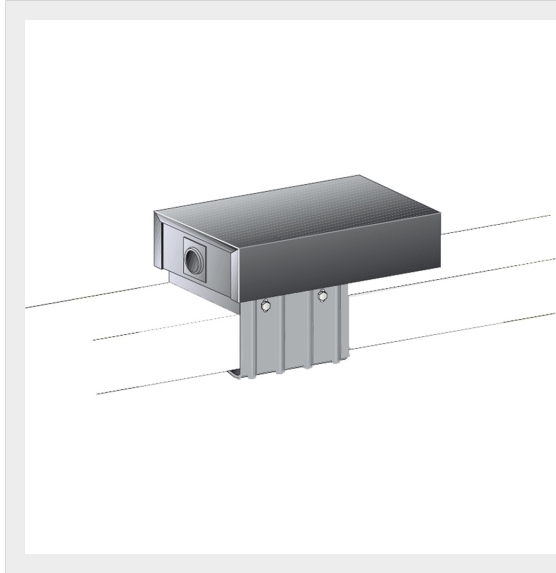

BTICINO > ZUCCHINI busbar > TS Trolley System > Feed units



80541101

Intermediate feed unit for busbar TS5 - In=70/110/150A

Technical features









Protection index	IP20
Standard reference	CEI EN 61439-6
Rated voltage	600V
Rated current	70/110/150A
Series	TS

Documentation

 [Instructions Sheet](#)

 [Busbar catalogue](#)

Related products

				
<p>80530401</p> <p>Curved element TS5 - 3P+N+T - In=70/110A - length 3m</p>	<p>80530102</p> <p>Straight element TS5 with Cu 3P+N+T - In=70/110A - length 1.5m</p>	<p>80540401</p> <p>Curved element TS5 - 3P+N+T - In=150A - length 3m</p>	<p>80540101</p> <p>Straight element TS5 with Cu 3P+N+T - In=150A - length 3m</p>	<p>80530301</p> <p>Straight element TS5 with expansion joint - 3P+N+T - In=70/110A - length 3m</p>
				
<p>80540102</p> <p>Straight element TS5 with Cu 3P+N+T - In=150A - length 1.5m</p>	<p>80530201</p> <p>Straight element TS5 with trolley introduction device - 3P+N+T - In=70/110A - length 3m</p>	<p>80530101</p> <p>Straight element TS5 with Cu 3P+N+T - In=110A - length 3m</p>	<p>80540201</p> <p>Straight element TS5 with trolley introduction device - 3P+N+T - In=150A - length 3m</p>	

We, Bticino S.p.A Viale Borri 231 21100 Varese (Italy), declare that all items listed in Bticino catalogues, have been manufactured in compliance with the principal elements of safety objectives of European Directive said LVD: 2014/35/EU: 26 February 2014 and, where requested, also in compliance with essential protection requirements of electromagnetic compatibility according to European Directive 2014/30/EU: 26 February 2014, and/or where requested also in compliance with 1995/5/CE: 9 March 1999 "R&TTE" or where requested also in compliance with 2014/53/EU: 16 April 2014 "RED". Bticino S.p.A, products are in compliance with the standard published by the International Electrotechnical Commission (IEC). The compliance can be proved by Certificates issued by organizations recognized by IEC according to the CB-scheme. Our items comply with relevant European Product- Standards and show, whether provided, CE marking, they have been constructed in accordance with good engineering practice in safety matters in force in the Community, they do not endanger the safety of persons, domestic animals or property when properly installed and maintained and used in applications for which they were made.