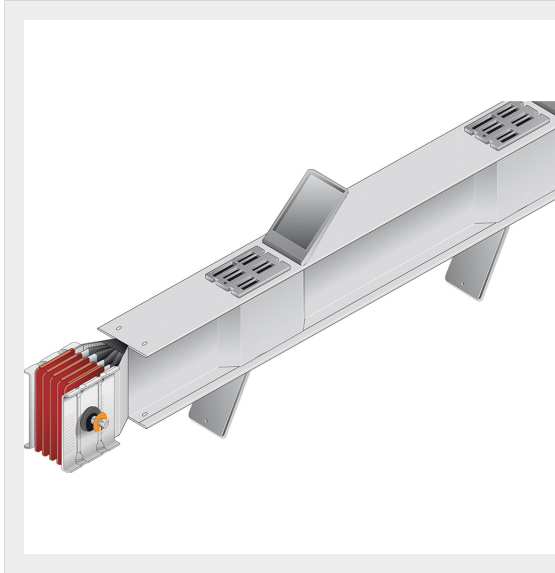

BTICINO > ZUCCHINI busbar > High power busbar > SCP Supercompact > Straight distribution elements

**65390955P**Straight element for energy distribution SCP Cu - length 2,5-3m -
In= 3200A - double bar

Technical features

Brand	BTicino
Standard reference	CEI EN 61439-6
Rated voltage	1000Vac
Rated current	3200A
Protection index	IP55
Length	2.5-3m
N° of compartments	2+2
Series	SCP

Documentation

 [Busbar catalogue](#)