

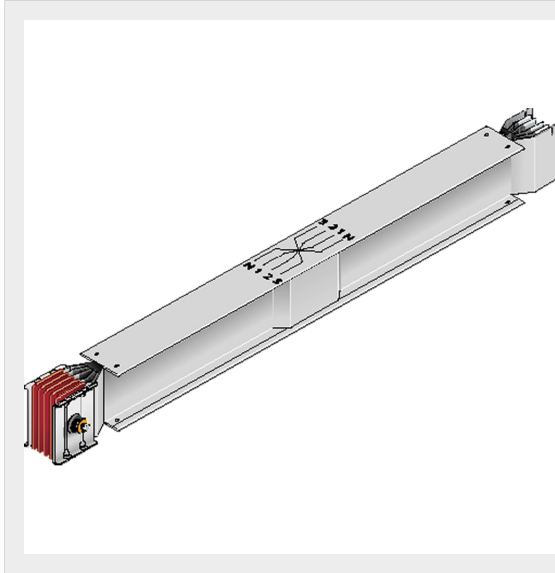

BTICINO > ZUCCHINI busbar > SCP Supercompact > Phase inversion straight elements



65287120P

Transposition straight element SCP Cu - In= 800A

Technical features

Protection index	IP55
Standard reference	CEI EN 61439-6
Rated voltage	1000V
Rated current	800A
Series	SCP

Documentation

 [Busbar catalogue](#)