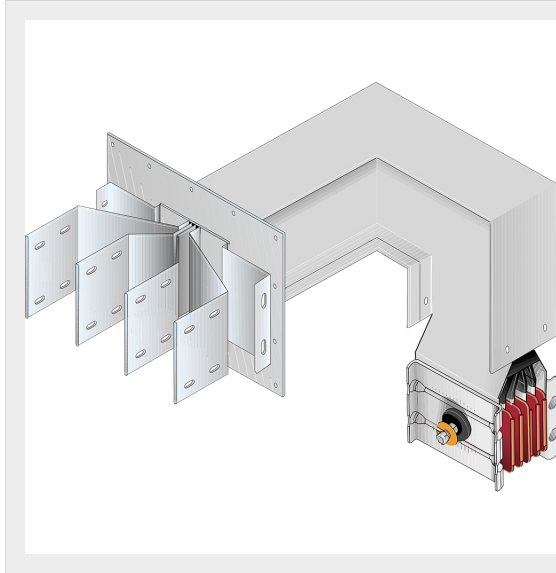

BTICINO > ZUCCHINI busbar > High power busbar > SCP Supercompact > Connection interface with horizontal + vertical elbow

**65281678P**

Busbar outlet element with horizontal + vertical elbow for busbar SCP - Type 8 Cu - In= 2500A

Technical features

Brand	BTicino
Standard reference	CEI EN 61439-6
Rated voltage	1000Va.c.
Rated current	2.5kA
Protection index	IP55
Series	SCP

Documentation

 [Busbar catalogue](#)