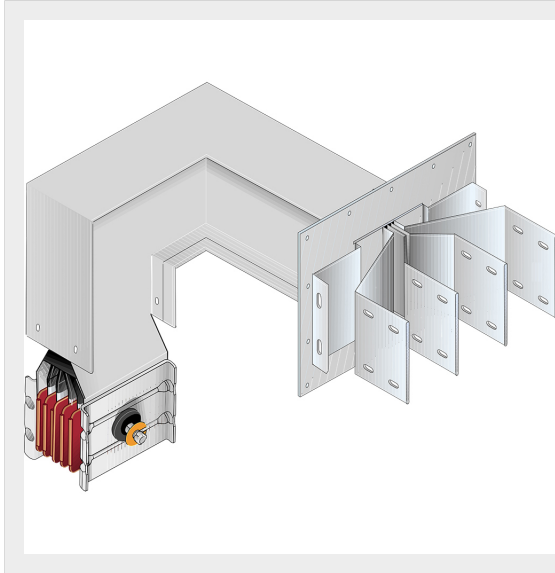

BTICINO &gt; ZUCCHINI busbar &gt; High power busbar &gt; SCP Supercompact &gt; Connection interface with horizontal + vertical elbow

**65281653P**

Busbar outlet element with horizontal + vertical elbow for busbar SCP - Type 6 Cu - In= 1250A

## Technical features

Brand	BTicino
Standard reference	CEI EN 61439-6
Rated voltage	1000Va.c.
Rated current	1250A
Protection index	IP55
Series	SCP

## Documentation

 [Busbar catalogue](#)