

> SCP Supercompact > Connection interface with horizontal + vertical elbow

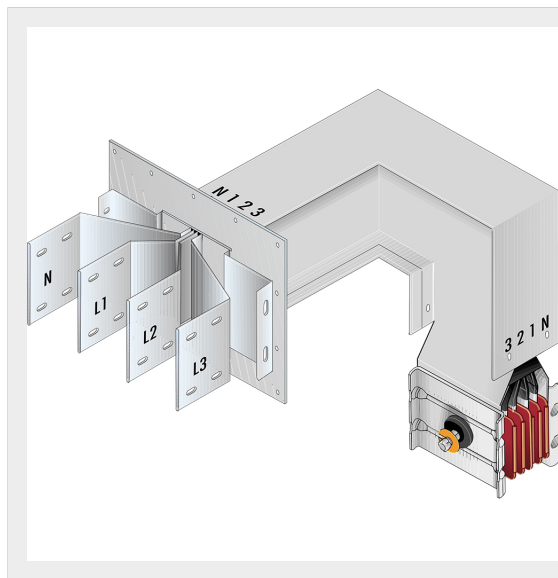

65281640P

Busbar outlet element with horizontal + vertical elbow for busbar SCP - Type 5 Cu - In= 800A

Technical features

Brand	BTicino
Standard reference	CEI EN 61439-6
Rated voltage	1000Vac
Rated current	800A
Protection index	IP55
Series	SCP

We, BTicino S.p.A Viale Borri 231 21100 Varese (Italy), declare that all items listed in BTicino catalogues, have been manufactured in compliance with the principal elements of safety objectives of European Directive said LVD: 2014/35/EU: 26 February 2014 and, where requested, also in compliance with essential protection requirements of electromagnetic compatibility according to European Directive 2014/30/EU: 26 February 2014, and/or where requested also in compliance with 1995/5/CE: 9 March 1999 "R&TTE" or where requested also in compliance with 2014/53/EU: 16 April 2014 "RED". BTicino S.p.A. products are in compliance with the standard published by the International Electrotechnical Commission (IEC). The compliance can be proved by Certificates issued by organizations recognized by IEC according to the CB-scheme. Our items comply with relevant European Product- Standards and show, whether provided, CE marking, they have been constructed in accordance with good engineering practice in safety matters in force in the Community, they do not endanger the safety of persons, domestic animals or property when properly installed and maintained and used in applications for which they were made.