

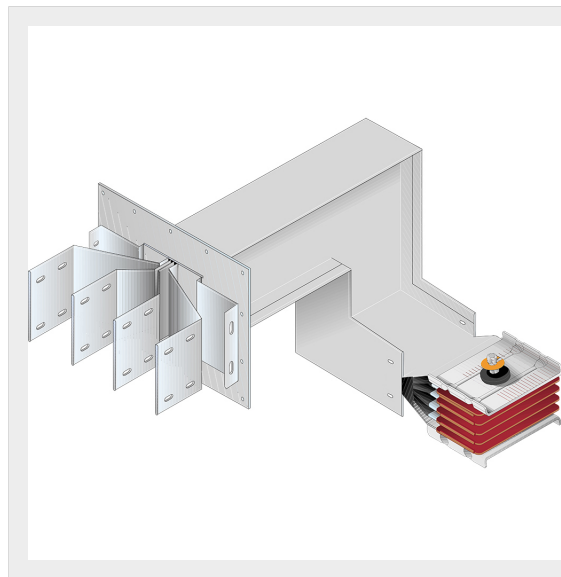

BTICINO > ZUCCHINI busbar > SCP Supercompact > Connection interface with vertical + horizontal elbow



65281575P

Busbar outlet element with vertical + horizontal elbow for busbar SCP - Type 8 Cu - In= 1600A

Technical features

Protection index	IP55
Standard reference	CEI EN 61439-6
Rated voltage	1000V
Rated current	1600A
Series	SCP

Documentation

 [Busbar catalogue](#)