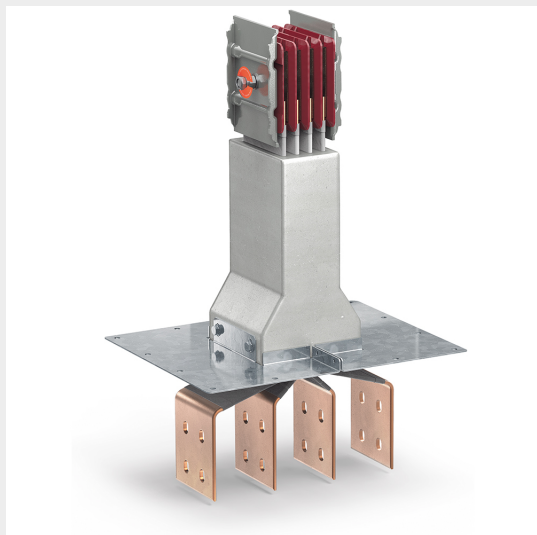

BTICINO > ZUCCHINI busbar > High power busbar > RCP resin busbar IP68 > Connection interfaces

**65281010R**

Connection interface left RCP in resin - conductors CU - rated current 800A

Technical features

Brand	BTicino
Standard reference	IEC 61439-6
Rated voltage	1000V
Rated current	800A
Protection index	IP55
Series	RCP

Documentation

-  [Installation manual](#)
-  [Busbar catalogue](#)
-  [Catalogue RCP](#)