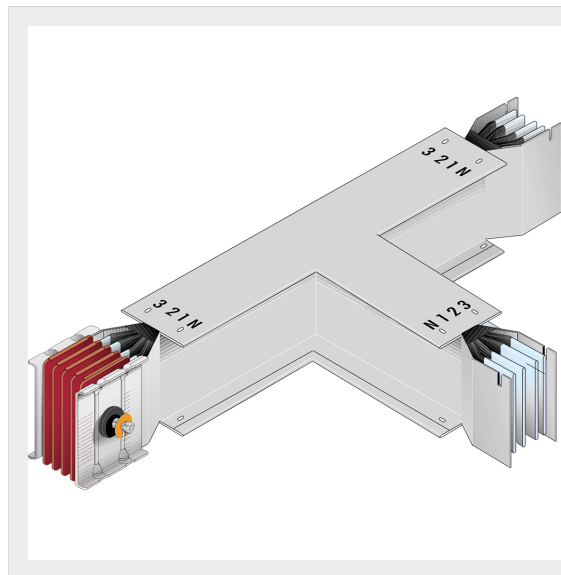

BTICINO > ZUCCHINI busbar > High power busbar > SCP Supercompact > Horizontal T-elements

**65280736P**

Horizontal T element SCP - Type 4 Cu - In= 2000A

Technical features

Brand	BTicino
Standard reference	CEI EN 61439-6
Rated voltage	1000Vac
Rated current	2000A
Protection index	IP55
Series	SCP

Documentation

 [Busbar catalogue](#)