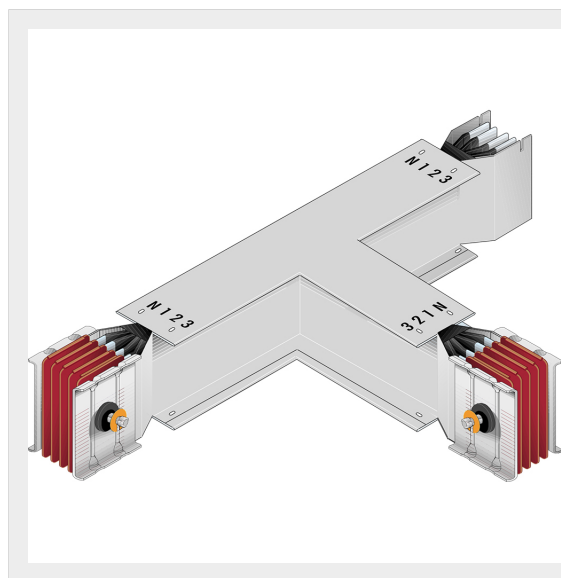

BTICINO &gt; ZUCCHINI busbar &gt; High power busbar &gt; SCP Supercompact &gt; Horizontal T-elements

**65280716P**

Horizontal T element SCP - Type 2 Cu - In= 2000A

## Technical features

Brand	BTicino
Standard reference	CEI EN 61439-6
Rated voltage	1000V
Rated current	2000A
Protection index	IP55
Series	SCP

## Documentation

 [Busbar catalogue](#)