

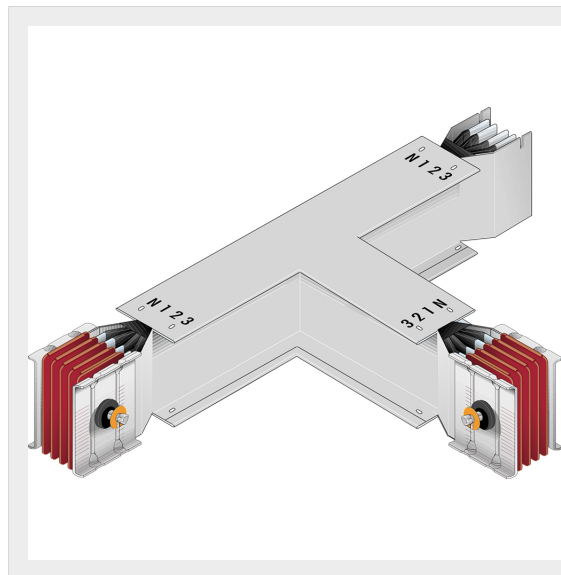

BTICINO > ZUCCHINI busbar > SCP Supercompact > Horizontal T-elements



65280711P

Horizontal T element SCP - Type 2 Cu - In= 1000A

Technical features

Protection index	IP55
Standard reference	CEI EN 61439-6
Rated voltage	1000V
Rated current	1000A
Series	SCP

Documentation

 [Busbar catalogue](#)