

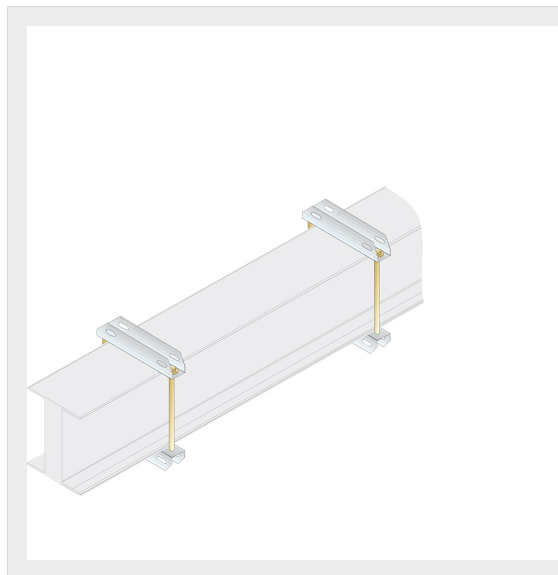

BTICINO &gt; ZUCCHINI busbar &gt; SCP Supercompact &gt; Brackets



65222003

Suspension bracket for SCP - Installation in edgewise or flat - In= 3200-4000A (Al/Cu)

## Technical features

Protection index	IP55
Standard reference	CEI EN 61439-6
Rated voltage	1000V
Rated current	3200-4000A
Series	SCP

## Documentation

 [Busbar catalogue](#)