

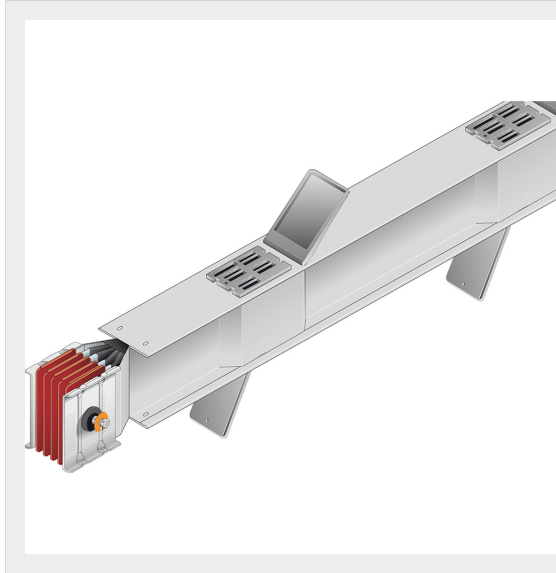

BTICINO > ZUCCHINI busbar > SCP Supercompact > Straight distribution elements



60280987P

Straight element for energy distribution SCP AI - length 2-2,5m - In= 2000A

Technical features

Protection index	IP55
Length	2-2.5m
Standard reference	CEI EN 61439-6
N° of compartments	2+2
Rated voltage	1000V
Rated current	2000A
Series	SCP

Documentation

 [Busbar catalogue](#)