

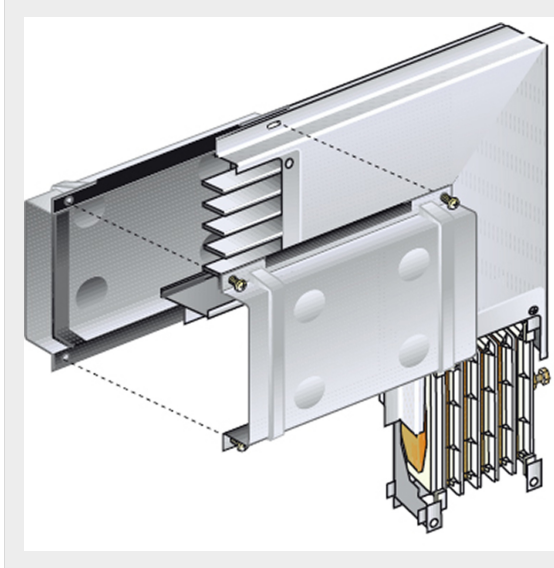

BTICINO > ZUCCHINI busbar > MR Medium Rating > Vertical elbows copper



55400413

Vertical elbow (left) in Cu for MR315 - In=315A - IP55

## Technical features

Protection index	IP55
Standard reference	CEI EN 61439-6
Rated voltage	1000V
Rated current	315A
Series	MR

## Documentation

 [Instructions Sheet](#)

 [Busbar catalogue](#)

## Related products



**55400123**

Straight element MR315  
Cu without outlets -  
In=315A - IP52 - length  
1-1.5m



**55400153**

Straight element MR315  
Cu with 2+2 outlets for  
side - In=315A - IP52 -  
length 1.5-3m



**55400113**

Straight element MR315  
Cu without outlets -  
In=315A - IP52 - length  
0.6-1m



**55400143**

Straight element MR315  
Cu with 1+1 outlets for  
side - In=315A - IP52 -  
length 1-1.5m



**55400243**

Straight element MR315  
Cu without outlets -  
In=315A - IP52 - length  
3m



**55400253**

Straight element MR315  
Cu with 5 outlets on one  
side only - In=315A -  
IP52 - length 3m



**55400103**

Straight element MR315  
Cu with 3+3 outlets for  
side - In=315A - IP52 -  
length 3m