

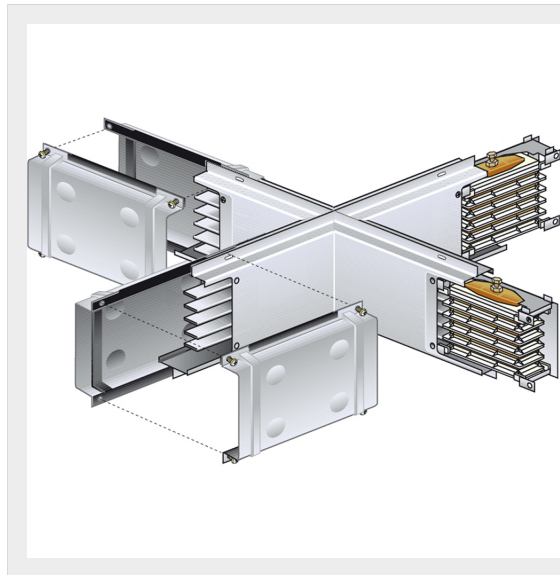

BTICINO > ZUCCHINI busbar > MR Medium Rating > T and cross elements



50403006

Cross element for busbar MR AI - In=800A - IP55

Technical features

Protection index	IP55
Standard reference	CEI EN 61439-6
Rated voltage	1000V
Rated current	800A
Series	MR

Documentation

 [Instructions Sheet](#)

 [Busbar catalogue](#)

Related products



50400156

Straight element MR800 AI with 2+2 outlets for side - In=800A - IP52 - length 1.5-3m



50400116

Straight element MR800 AI without outlets - In=800A - IP52 - length 0.6-1m



50400146

Straight element MR800 AI with 1+1 outlets for side - In=800A - IP52 - length 1-1.5m



50400246

Straight element MR800 AI without outlets - In=800A - IP52 - length 3m



50400256

Straight element MR800 AI with 5 outlets on one side only - In=800A - IP52 - length 3m



50400106

Straight element MR800 AI with 3+3 outlets for side - In=800A - IP52 - length 3m



50400126

Straight element MR800 AI without outlets - In=800A - IP52 - length 1-1.5m