

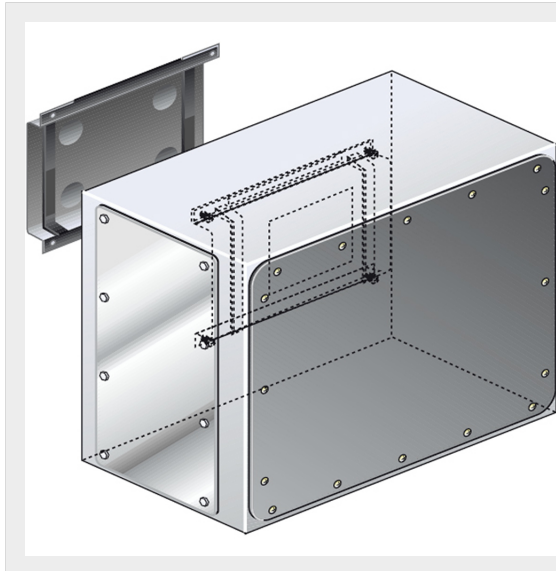

## GENERAL CATALOGUE

BTICINO &gt; ZUCCHINI busbar &gt; MR Medium Rating &gt; Aluminium Feed units



50401206

Intermediate feed unit for busbar AI MR800 - In=800A - IP55

## Technical features

Protection index	IP55
Standard reference	CEI EN 61439-6
Rated voltage	1000V
Rated current	800A
Series	MR

## Documentation

[!\[\]\(cf531ed27e91483460120fcc057b3901\_img.jpg\) Instructions Sheet](#) 
[!\[\]\(d3102649f02e825ddb76dc3de0190154\_img.jpg\) Busbar catalogue](#)

## Related products



**50400276-1600**

Data Center straight elements (IP40). Aluminium conductors and windows on both sides (2+2, step 800m...



**50400266**

Data Center straight elements (IP40). Aluminium conductors and windows on both sides (5+5, step 600m...



**50400266-2400**

Data Center straight elements (IP40). Aluminium conductors and windows on both sides (4+4, step 600m...



**50400266-1200**

Data Center straight elements (IP40). Aluminium conductors and windows on both sides (2+2, step 600m...



**50400276-2400**

Data Center straight elements (IP40). Aluminium conductors and windows on both sides (3+3, step 800m...



**50400126**

Straight element MR800 AI without outlets - In=800A - IP52 - length 1-1.5m



**50400156**

Straight element MR800 AI with 2+2 outlets for side - In=800A - IP52 - length 1.5-3m



**50400116**

Straight element MR800 AI without outlets - In=800A - IP52 - length 0.6-1m



**50400146**

Straight element MR800 AI with 1+1 outlets for side - In=800A - IP52 - length 1-1.5m



**50400246**

Straight element MR800 AI without outlets - In=800A - IP52 - length 3m