

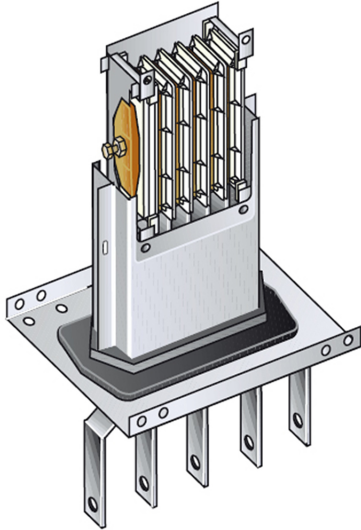

BTICINO > ZUCCHINI busbar > MR Medium Rating > Aluminium Feed units



50401013

Left feed unit from cabinet to transformers for busbar in Al
MR315 - In=315A - IP55

Technical features

Protection index	IP55
Standard reference	CEI EN 61439-6
Rated voltage	1000V
Rated current	315A
Series	MR

Documentation

 [Instructions Sheet](#)

 [Busbar catalogue](#)

Related products



50400263

Data Center straight elements (IP40). Aluminium conductors and windows on both sides (5+5, step 600m...



50400263-2400

Data Center straight elements (IP40). Aluminium conductors and windows on both sides (4+4, step 600m...



50400263-1200

Data Center straight elements (IP40). Aluminium conductors and windows on both sides (2+2, step 600m...



50400273-2400

Data Center straight elements (IP40). Aluminium conductors and windows on both sides (3+3, step 800m...



50400273-1600

Data Center straight elements (IP40). Aluminium conductors and windows on both sides (2+2, step 800m...



50400113

Straight element MR315 AI without outlets - In=315A - IP52 - length 0.6-1m



50400143

Straight element MR315 AI with 1+1 outlets for side - In=315A - IP52 - length 1-1.5m



50400243

Straight element MR315 AI without outlets - In=315A - IP52 - length 3m



50400253

Straight element MR315 AI with 5 outlets on one side only - In=315A - IP52 - length 3m



50400103

Straight element MR315 AI with 3+3 outlets for side - In=315A - IP52 - length 3m