

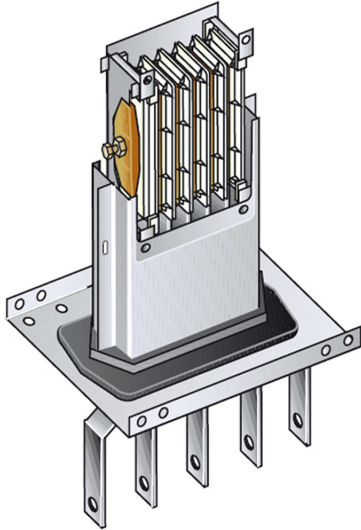

BTICINO > ZUCCHINI busbar > MR Medium Rating > Aluminium Feed units



50401012

Left feed unit from cabinet to transformers for busbar in Al
MR250 - In=250A - IP55

Technical features











Protection index	IP55
Standard reference	CEI EN 61439-6
Rated voltage	1000V
Rated current	250A
Series	MR

Documentation

 [Instructions Sheet](#)

 [Busbar catalogue](#)

Related products

 <p>50400262-2400</p> <p>Data Center straight elements (IP40). Aluminium conductors and windows on both sides (4+4, step 600m...</p>	 <p>50400262-1200</p> <p>Data Center straight elements (IP40). Aluminium conductors and windows on both sides (2+2, step 600m...</p>	 <p>50400272-2400</p> <p>Data Center straight elements (IP40). Aluminium conductors and windows on both sides (3+3, step 800m...</p>	 <p>50400272-1600</p> <p>Data Center straight elements (IP40). Aluminium conductors and windows on both sides (2+2, step 800m...</p>	 <p>50400262</p> <p>Data Center straight elements (IP40). Aluminium conductors and windows on both sides (5+5, step 600m...</p>
 <p>50400252</p> <p>Straight element MR250 AI with 5 outlets on one side only - In=250A - IP52 - length 3m</p>	 <p>50400102</p> <p>Straight element MR250 AI with 3+3 outlets for side - In=250A - IP52 - length 3m</p>	 <p>50400122</p> <p>Straight element MR250 AI without outlets - In=250A - IP52 - length 1-1.5m</p>	 <p>50400152</p> <p>Straight element MR250 AI with 2+2 outlets for side - In=250A - IP52 - length 1.5-3m</p>	 <p>50400112</p> <p>Straight element MR250 AI without outlets - In=250A - IP52 - length 0.6-1m</p>