

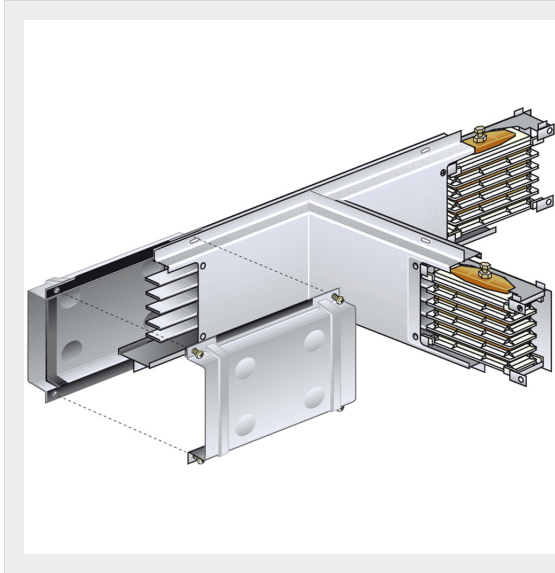

BTICINO > ZUCCHINI busbar > MR Medium Rating > T and cross elements



50400723

Horizontal standard T elements for busbar MR AI - In=315A

## Technical features

Protection index	IP55
Width	300mm
Length	300mm
Depth	300mm
Standard reference	CEI EN 61439-6
Rated current	315A
Series	MR

## Documentation

 [Instructions Sheet](#)

 [Busbar catalogue](#)