

BTICINO > ZUCCHINI busbar > Medium power busbar > MR Medium Rating > T and cross elements

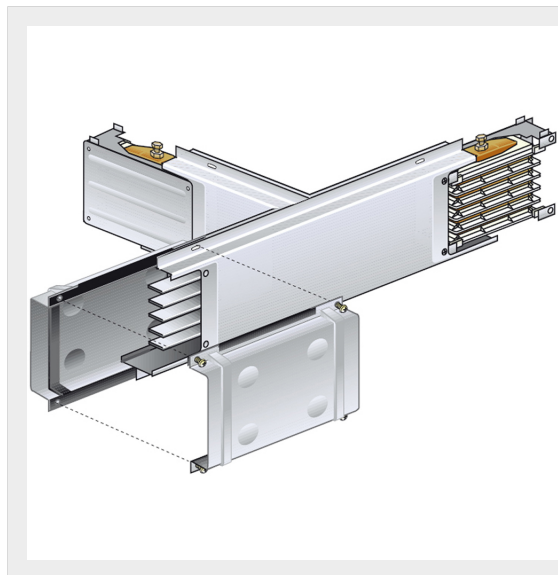

50400718

Horizontal standard T elements for busbar MR AI - In=500A

Technical features

Brand	BTicino
Standard reference	CEI EN 61439-6
Rated current	500A
Protection index	IP55
Width	300mm
Length	300mm
Depth	300mm
Series	MR

Documentation

 [Installation manual](#) [Busbar catalogue](#)