

BTICINO &gt; ZUCCHINI busbar &gt; Medium power busbar &gt; MR Medium Rating &gt; T and cross elements

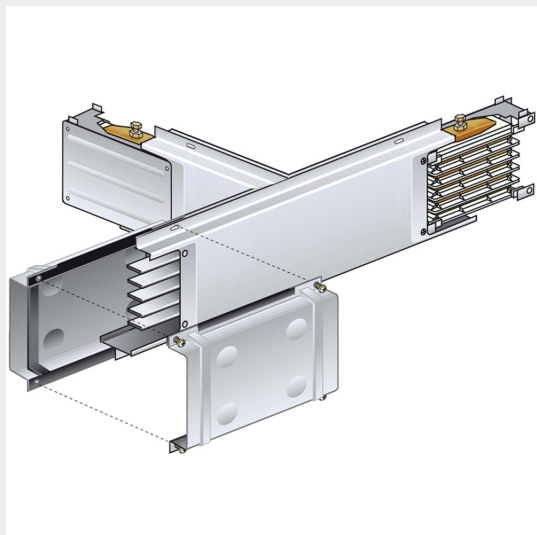

50400712

Horizontal standard T elements for busbar MR AI - In=250A

## Technical features

Brand	BTicino
Standard reference	CEI EN 61439-6
Rated current	250A
Protection index	IP55
Width	300mm
Length	300mm
Depth	300mm
Series	MR

## Documentation

 [Installation manual](#) [Busbar catalogue](#)