

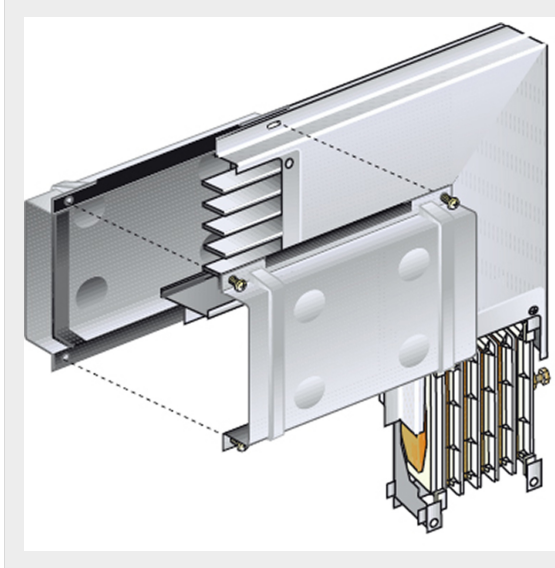

BTICINO > ZUCCHINI busbar > MR Medium Rating > Vertical elbows aluminium



50400416

Vertical elbow (left) in Al for MR800 - In=800A - IP55

## Technical features











Protection index	IP55
Standard reference	CEI EN 61439-6
Rated voltage	1000V
Rated current	800A
Series	MR

## Documentation

 [Instructions Sheet](#)

 [Busbar catalogue](#)

## Related products

 <p><b>50400266-2400</b></p> <p>Data Center straight elements (IP40). Aluminium conductors and windows on both sides (4+4, step 600m...</p>	 <p><b>50400266-1200</b></p> <p>Data Center straight elements (IP40). Aluminium conductors and windows on both sides (2+2, step 600m...</p>	 <p><b>50400276-2400</b></p> <p>Data Center straight elements (IP40). Aluminium conductors and windows on both sides (3+3, step 800m...</p>	 <p><b>50400276-1600</b></p> <p>Data Center straight elements (IP40). Aluminium conductors and windows on both sides (2+2, step 800m...</p>	 <p><b>50400266</b></p> <p>Data Center straight elements (IP40). Aluminium conductors and windows on both sides (5+5, step 600m...</p>
 <p><b>50400246</b></p> <p>Straight element MR800 AI without outlets - In=800A - IP52 - length 3m</p>	 <p><b>50400256</b></p> <p>Straight element MR800 AI with 5 outlets on one side only - In=800A - IP52 - length 3m</p>	 <p><b>50400106</b></p> <p>Straight element MR800 AI with 3+3 outlets for side - In=800A - IP52 - length 3m</p>	 <p><b>50400126</b></p> <p>Straight element MR800 AI without outlets - In=800A - IP52 - length 1-1.5m</p>	 <p><b>50400156</b></p> <p>Straight element MR800 AI with 2+2 outlets for side - In=800A - IP52 - length 1.5-3m</p>