

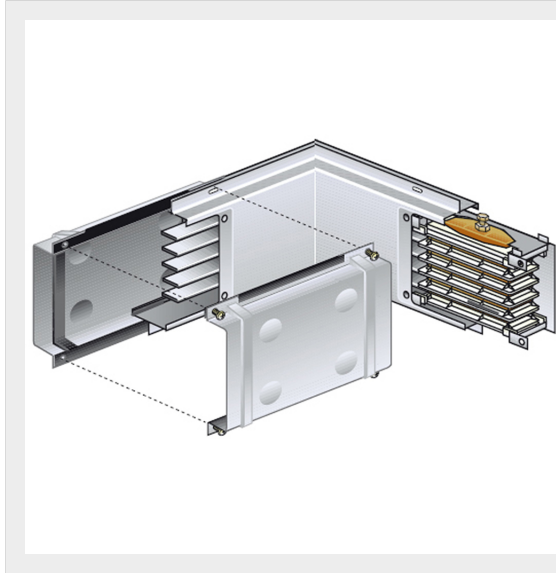

BTICINO > ZUCCHINI busbar > MR Medium Rating > Horizontal elbows aluminium



50400316

Horizontal elbow (left) in Al for MR800 - In=800A - IP55 - length 300+300mm

## Technical features

Protection index	IP55
Length	0.3+0.3m
Standard reference	CEI EN 61439-6
Rated voltage	1000V
Rated current	800A
Series	MR

## Documentation

[Instructions Sheet](#)

[Busbar catalogue](#)

## Related products



**50400276-2400**

Data Center straight elements (IP40). Aluminium conductors and windows on both sides (3+3, step 800m...



**50400276-1600**

Data Center straight elements (IP40). Aluminium conductors and windows on both sides (2+2, step 800m...



**50400266**

Data Center straight elements (IP40). Aluminium conductors and windows on both sides (5+5, step 600m...



**50400266-2400**

Data Center straight elements (IP40). Aluminium conductors and windows on both sides (4+4, step 600m...



**50400266-1200**

Data Center straight elements (IP40). Aluminium conductors and windows on both sides (2+2, step 600m...



**50400106**

Straight element MR800 AI with 3+3 outlets for side - In=800A - IP52 - length 3m



**50400126**

Straight element MR800 AI without outlets - In=800A - IP52 - length 1-1.5m



**50400156**

Straight element MR800 AI with 2+2 outlets for side - In=800A - IP52 - length 1.5-3m



**50400116**

Straight element MR800 AI without outlets - In=800A - IP52 - length 0.6-1m



**50400146**

Straight element MR800 AI with 1+1 outlets for side - In=800A - IP52 - length 1-1.5m