

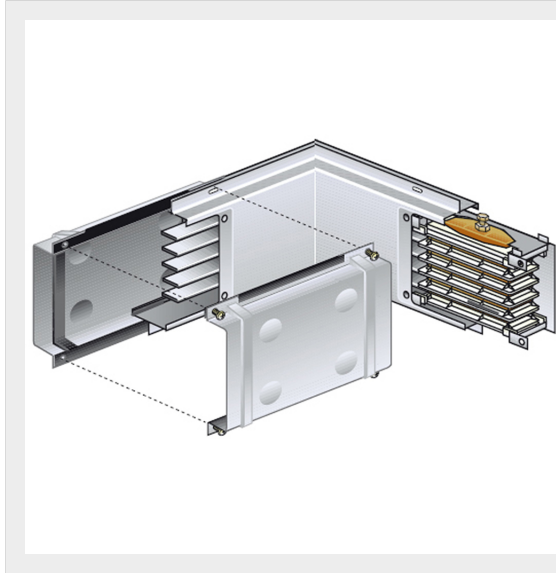

BTICINO &gt; ZUCCHINI busbar &gt; MR Medium Rating &gt; Horizontal elbows aluminium



50400315

Horizontal elbow (left) in Al for MR630 - In=630A - IP55 - length 300+300mm

## Technical features











Protection index	IP55
Length	0.3+0.3m
Standard reference	CEI EN 61439-6
Rated voltage	1000V
Rated current	630A
Series	MR

## Documentation

 [Instructions Sheet](#)

 [Busbar catalogue](#)

## Related products

 <p><b>50400275-1600</b></p> <p>Data Center straight elements (IP40). Aluminium conductors and windows on both sides (2+2, step 800m...</p>	 <p><b>50400265</b></p> <p>Data Center straight elements (IP40). Aluminium conductors and windows on both sides (5+5, step 600m...</p>	 <p><b>50400265-2400</b></p> <p>Data Center straight elements (IP40). Aluminium conductors and windows on both sides (4+4, step 600m...</p>	 <p><b>50400265-1200</b></p> <p>Data Center straight elements (IP40). Aluminium conductors and windows on both sides (2+2, step 600m...</p>	 <p><b>50400275-2400</b></p> <p>Data Center straight elements (IP40). Aluminium conductors and windows on both sides (3+3, step 800m...</p>
 <p><b>50400125</b></p> <p>Straight element MR630 AI without outlets - In=630A - IP52 - length 1-1.5m</p>	 <p><b>50400155</b></p> <p>Straight element MR630 AI with 2+2 outlets for side - In=630A - IP52 - length 1.5-3m</p>	 <p><b>50400115</b></p> <p>Straight element MR630 AI without outlets - In=630A - IP52 - length 0.6-1m</p>	 <p><b>50400145</b></p> <p>Straight element MR630 AI with 1+1 outlets for side - In=630A - IP52 - length 1-1.5m</p>	 <p><b>50400245</b></p> <p>Straight element MR630 AI without outlets - In=630A - IP52 - length 3m</p>

We, Bticino S.p.A Viale Borri 231 21100 Varese (Italy), declare that all items listed in Bticino catalogues, have been manufactured in compliance with the principal elements of safety objectives of European Directive said LVD: 2014/35/EU: 26 February 2014 and, where requested, also in compliance with essential protection requirements of electromagnetic compatibility according to European Directive 2014/30/EU: 26 February 2014, and/or where requested also in compliance with 1995/5/CE: 9 March 1999 "R&TTE" or where requested also in compliance with 2014/53/EU: 16 April 2014 "RED". Bticino S.p.A. products are in compliance with the standard published by the International Electrotechnical Commission (IEC). The compliance can be proved by Certificates issued by organizations recognized by IEC according to the CB-scheme. Our items comply with relevant European Product- Standards and show, where provided, CE marking, they have been constructed in accordance with good engineering practice in safety matters in force in the Community, they do not endanger the safety of persons, domestic animals or property when properly installed and maintained and used in applications for which they were made.