

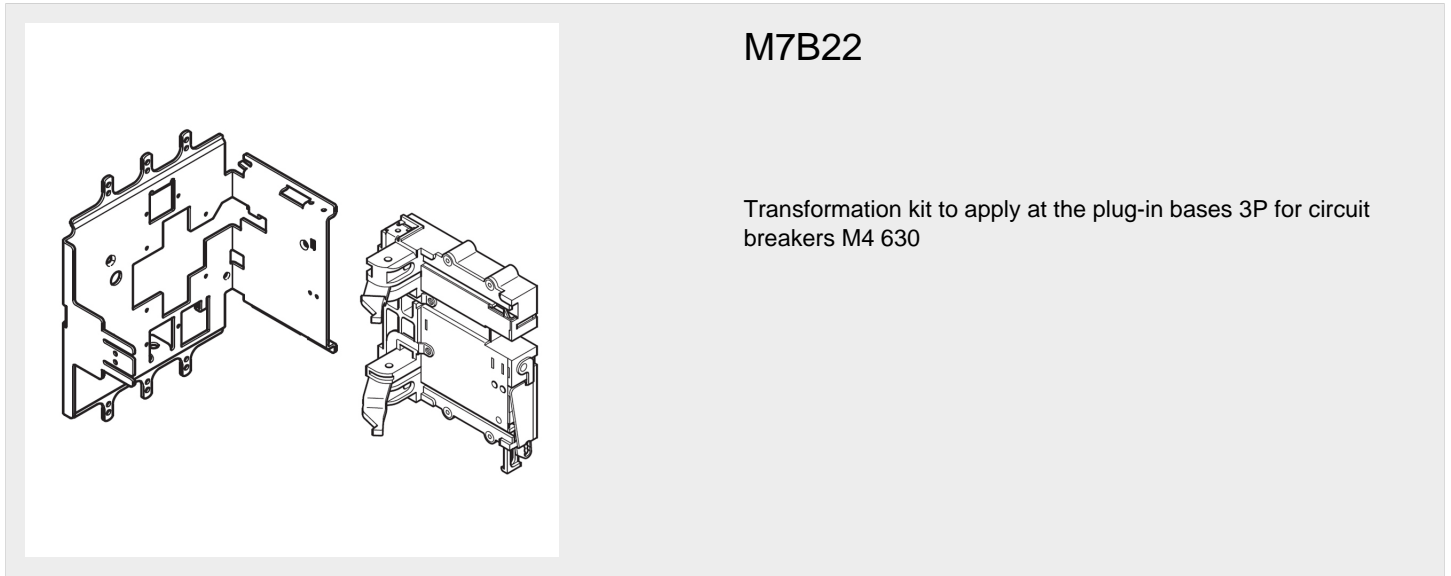

BTICINO &gt; Low voltage energy distribution &gt; MEGATIKER - moulded case circuit breakers &gt; Accessories for draw-out/plug-in version



## Technical features

Standard reference	CEI EN 60947-2
N° of poles	3P
Series	Megatiker

## Documentation

-  [Instructions Sheet](#)
-  [Catalogue Megatiker](#)

## Related products

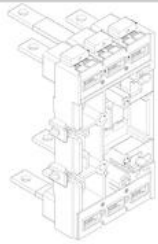

### M7B15

Base 3P with rear terminals for circuit breakers M4 630 plug-in/draw-out version

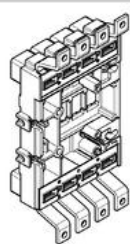

### M7B14

Base 4P with front terminals for circuit breakers M4 630 plug-in/draw-out version

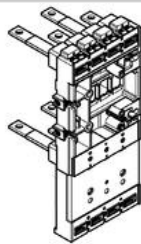

### M7B18

Base 4P+ELM with rear terminals (flat) for circuit breakers M4 630 plug-in/draw-out version (with ea...

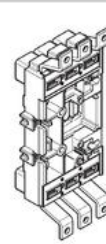

### M7B13

Base 3P with front terminals for circuit breakers M4 630 plug-in/draw-out version

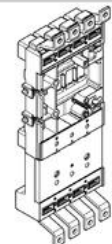

### M7B17

Base 4P+ELM with rear terminals for circuit breakers M4 630 plug-in/draw-out version (with earth lea...

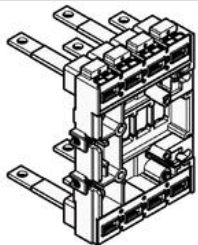

### M7B16

Base 4P with rear terminals for circuit breakers M4 630 plug-in/draw-out version