

BTICINO > Low voltage energy distribution > Distribution boards and enclosures > MAS400 - Compact distribution boards and cabinets > Metal sheet blanking module with 4 screws

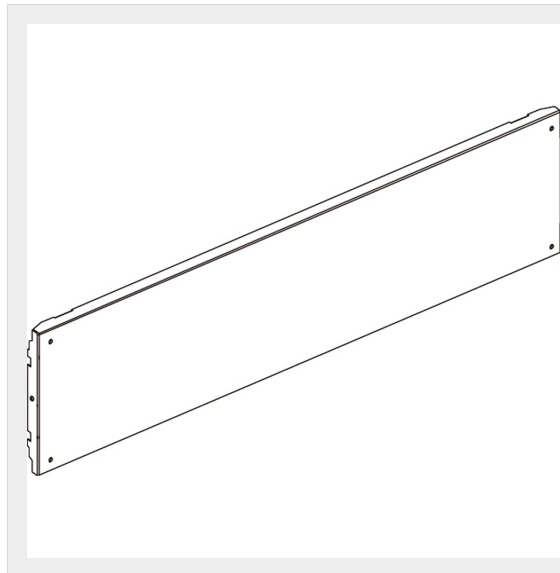



**9780**

Blank front panel with 4 screws 850x200mm

Technical features

Brand	BTicino
Standard reference	CEI EN 61439-1/2
Height	200mm
Width	850mm
Series	Mas

Documentation

-  [Instruction Sheet](#)
-  [Mas800 catalogue](#)
-  [Mas400 catalogue](#)
-  [Mas4000 catalogue](#)