

BTICINO > Low voltage energy distribution > Distribution boards and enclosures > MAS400 - Compact distribution boards and cabinets > Front cover panels for MEGASWITCH

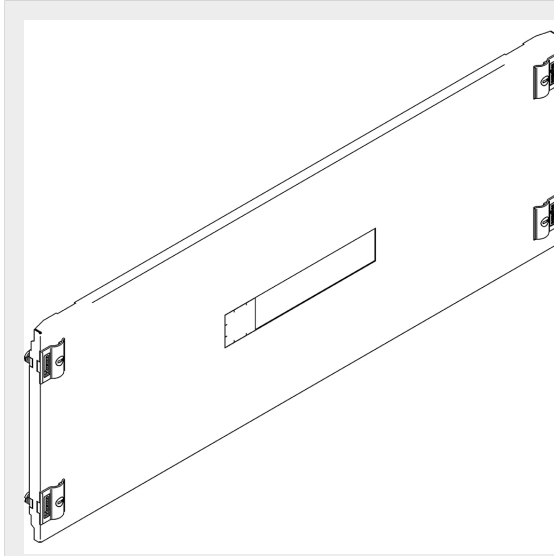





9761/1WQ

Front panel with screws 1/4 turn for 1 disconnector MW250
850x300mm

Technical features

Brand	BTicino
Standard reference	CEI EN 61439-1/2
Height	300mm
Width	850mm
Series	Mas

Documentation

-  [DWG drawing](#)
-  [Mas800 catalogue](#)
-  [Mas400 catalogue](#)
-  [Mas4000 catalogue](#)

Related products

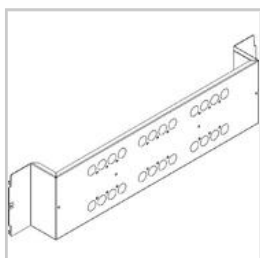

9761PC/W

Fixing plate for MW250
for LDX-P, LDX400 and
MDX400 width 850mm

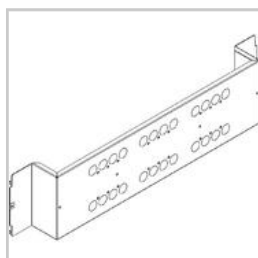

9761P/W

Fixing plate for MW250
for LDX800, MDX800
and HDX width 850mm

We, Bticino S.p.A Viale Borri 231 21100 Varese (Italy), declare that all items listed in Bticino catalogues, have been manufactured in compliance with the principal elements of safety objectives of European Directive said LVD: 2014/35/EU: 26 February 2014 and, where requested, also in compliance with essential protection requirements of electromagnetic compatibility according to European Directive 2014/30/EU: 26 February 2014, and/or where requested also in compliance with 1995/5/CE: 9 March 1999 "R&TTE" or where requested also in compliance with 2014/53/EU: 16 April 2014 "RED". Bticino S.p.A. products are in compliance with the standard published by the International Electrotechnical Commission (IEC). The compliance can be proved by Certificates issued by organizations recognized by IEC according to the CB-scheme. Our items comply with relevant European Product- Standards and show, whether provided, CE marking, they have been constructed in accordance with good engineering practice in safety matters in force in the Community, they do not endanger the safety of persons, domestic animals or property when properly installed and maintained and used in applications for which they were made.

