

BTICINO > Low voltage energy distribution > Distribution boards and enclosures > MAS400 - Compact distribution boards and cabinets > Front cover panels for MEGASWITCH

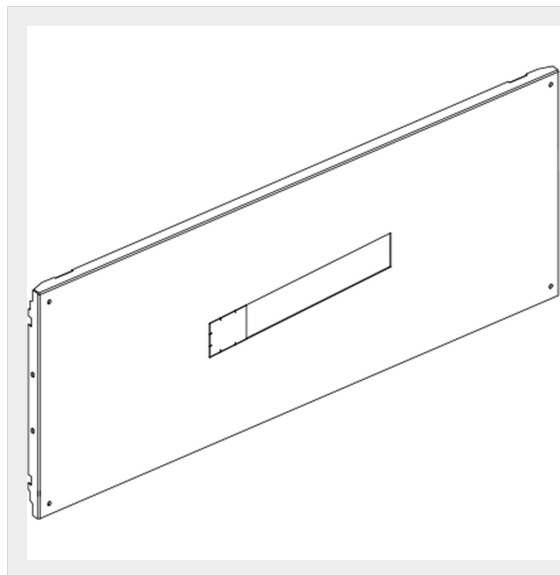





## 9761/1W

Front panel with 4 screws for 1 disconnector MW250  
850x300mm

### Technical features

Brand	BTicino
Standard reference	CEI EN 61439-1/2
Height	300mm
Width	850mm
Series	Mas

### Documentation

-  [Instruction Sheet](#)
-  [DWG drawing](#)
-  [Mas800 catalogue](#)
-  [Mas400 catalogue](#)
-  [Mas4000 catalogue](#)

## Related products

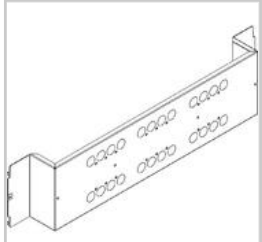

### 9761PC/W

Fixing plate for MW250  
for LDX-P, LDX400 and  
MDX400 width 850mm

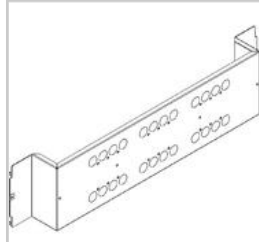

### 9761P/W

Fixing plate for MW250  
for LDX800, MDX800  
and HDX width 850mm