

BTICINO > Low voltage energy distribution > MAS400 - Compact distribution boards and cabinets > Device-holder panels

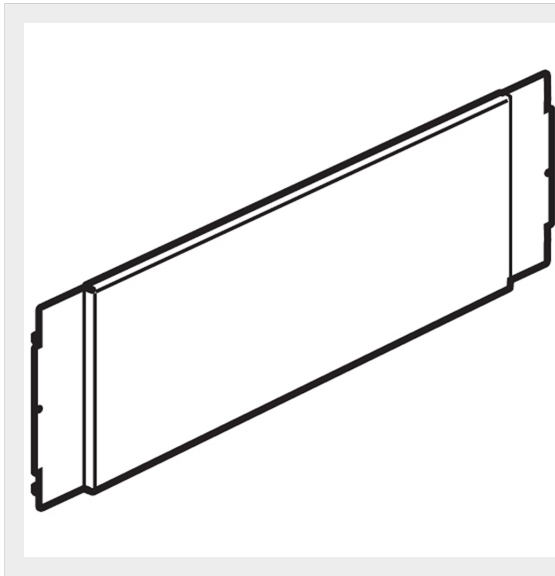

**9540L**

Metal sheet internal plate 600x200mm

Technical features

Height	200mm
Width	600mm
Standard reference	CEI EN 61439-1/2
Series	Mas

Documentation

-  [Mas800 catalogue](#)
-  [Mas400 catalogue](#)
-  [Mas4000 catalogue](#)