

Contents	Page
1. General characteristics	2
2. Overall dimensions	3
3. Technical characteristics	3
4. Conformity	6
5. Mounting	6
6. Accessories	8

1. GENERAL CHARACTERISTICS

1.1 Brief description

SPDs Type 1+2 (T1+T2) : surge protective devices for installations supplied with 230/400 V~ (50-60 Hz). Products based on spark gap technology according to EN 61643-11 (Class I+II according to IEC 61643-11).

Equipped with plug-in modules with status indicator:

- Green: SPD operational
- Red: plug-in module needs to be replaced

Equipped with an auxiliary unit for the remote monitoring of the SPD status.

SPDs T1+T2 (class I+II) : recommended for power installations with lightning conductors or LPS and installations according to EN/IEC 62305 standards.

LPS: lightning protection system according to standards EN/IEC 62305

1.2 Protection modes

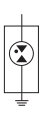
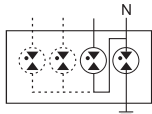
1P	3P+N
TT, TNS, IT	TT, TNS
	
F10VX1	F10T4



IT 230/400 V~ → use Cat. No. F10VX1 (Uc 440 V~)

Two-phase mains power supplies

Use SPDs Cat. No. F10VX1

1.3 Applications

1.3.1 Installation standards

1.3.1.1 CEI 64-8

According to part 443, SPDs are needed according to the results of the risk analysis based on EN/IEC 62305-2 (CEI 81-10/2). See 1.3.3

1.3.1.2 HD 60364, IEC 60364

According to articles 443 and 534 of standards HD/IEC 60364 and guides TS/IEC 61643-12, the use of SPDs in new or renovated buildings is compulsory at the supply end of the installation in the following cases:

- Buildings with lightning conductors or a LPS (T1 or T1+T2 SPDs, Iimp ≥ 12.5 kA)
- Buildings with totally or partially overhead power supplies in AQ2 geographical areas (article 443.3.2.1 - AQ2: Nk > 25) and based on a risk assessment taking into account the type of power supply to the building (article 443.3.2.2)

According to article 443.3.2.2, SPDs (type 2) are also required in the following cases:

- Commercial/industrial buildings, public services, religious buildings, schools, large residential complexes, etc.
- Hospitals and buildings containing medical equipment and/or security systems for people and property (fire alarms, technical alarms, etc)

1.3.2 BTicino recommendations

To ensure correct protection, an SPD is recommended:

- at the origin of each installation (compulsory depending on the type and location of the installation to be protected)
- at secondary distribution board feeding sensitive equipment
- on all outdoor electrical circuit outgoing lines (power supply for secondary buildings, outdoor lighting or outdoor distribution boards, etc).

It is advisable to install an SPD when the safety of people may depend on the continuity of service of equipment (even if this is not required by national standards). Although not compulsory according to the installation standards, an SPD should always be installed for communication networks to protect the communication equipment when there is an SPD on the low voltage power network.

To define the type of SPD needed according to the installation level of risk, use the selection chart (see catalogue) or our XL PRO³ and XL PRO³ Calcul software.

1.3.3 EN 62305 (IEC 62305)

An external lightning protection system (LPS) protects buildings against direct lightning strikes. It is generally based on the use of lightning conductors (single rods, with ESE, meshed cage, etc.) and/or the metal structure of the building.

If there is an LPS or a lightning risk assessment has been carried out in accordance with standards EN/IEC 62305, SPDs are generally required in the main distribution board (T1 or T1+T2 SPDs) and distribution boards (T2 SPDs).

Determination of SPDs in the main distribution board according to EN/IEC 62305 and TS/IEC 61643-12 (if there is insufficient information available):

Buildings with an external LPS

LPL ⁽¹⁾ : Lightning protection level	LPS total lightning current	Min. value of the SPD Iimp current (T1 or T1+T2)	Usage practices
I	200 kA	25 kA/pole (IT: 35 kA min.)	Power installations
II	150 kA	18.5 kA/pole	Rarely used
III/IV	100 kA	12.5 kA/pole	Small installations

(1): LPL (Lightning Protection Level)

Note:

According to standards EN/IEC 62305, T1 or T1+T2 SPDs may also be required if there is a risk of direct impact on power lines (EN/IEC 62305-1 table E.2). However, according to standard EN 62305-4 (appendix C.2.2), this is only the case if a risk of direct impact on the last 50 m of the line really exists and if this risk really has to be taken into account.

Risk assessment according to EN/IEC 62305

The risk assessment aims to evaluate if protective measures are needed. It defines their type and the level of needs to protect a building against lightning impacts (lightning protection of the building with an external LPS) and to protect equipment against impacts on the power or data lines, and against transient overvoltages due to lightning impacts on the LPS or close to the building.

To evaluate if protective measures are needed, it takes into account the following criteria :

- dimensions and type of construction of the building, type and level of use, type and number of lines entering the building, surrounding environment and local lightning density, number of persons usually present, etc...
- possible origins of the threats (S1: impacts on the building, S2: impacts close to the building, S3: impacts on the lines, S4: impacts close to the lines)
- possible losses or damages (L1: human safety, L2: public services, L3: cultural heritage and L4: economic value)
- and the level of acceptable risks depending on the type of building and its final use.

When the calculated risk is too high (higher than the acceptable level), protective measures must be implemented (LPS, SPDs, earthings, ...) and adapted to the level of needs. This level of needs is expressed in terms of LPL (Lightning Protection Level) with values ranging from I to IV, a LPL of I being the highest level of needs corresponding to a lightning current discharge of 200kA on the SPF and to SPDs of 100kA (25kA/pole for 4P SPDs) to be installed at the main board. LPL : see table above.

2. OVERALL DIMENSIONS

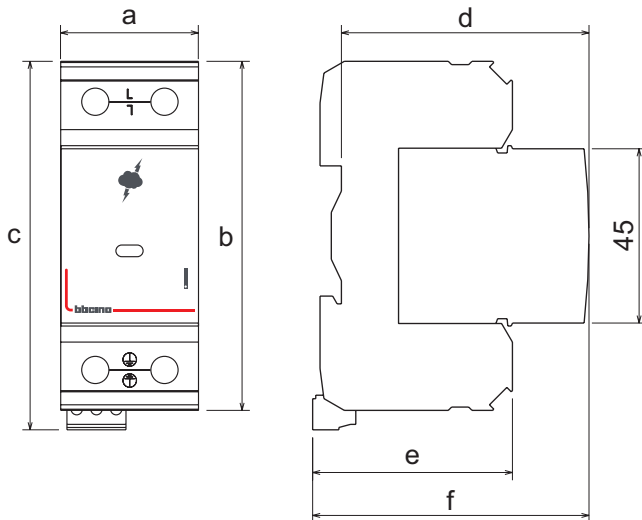

Type of SPD	Dimensions (mm)					
	a	b	c	d	e	f
1P	35,6	90	97	63,7	51,5	71,2
3P+N	142,4	90	97	63,7	51,5	71,2

3. TECHNICAL CHARACTERISTICS

3.1 Operating positions

Fixed on DIN 35 rail

3.2 Enclosure materials

Base:
PBT-FR
PA6.6 FR 20% GF
Colour: RAL 7035 light grey

Plug-in module:
Fibreglass reinforced (30%) polybutylene terephthalate (PBT)
Colour: RAL 7035 light grey

3.3 Resistance to shock and vibrations

Sinusoidal vibrations
- Frequency range: 5 to 500 Hz
- Acceleration: 5 g where $g = 9.81 \text{ m/s}^2$

Shock
- Acceleration: 25 g where $g = 9.81 \text{ m/s}^2$
(F10VX1 = 30g)

3.4 Operating characteristics

3.4.1 General characteristics

SPDs T1+T2 - 3P+N

Cat. Nos.		F10T4	
Number of poles		3P+N	
Type of SPD		T1+T2/25 kA	
Mains supply		230/400 V~	
Maximum supply fluctuation		10%	
Frequency		50/60 Hz	
Earthing system		TT, TNS	
Protection modes		L-N/N-PE/L-PE	
Max. continuous operating voltage (Uc)		L-N	350 V~
		N-PE	350 V~
		L-PE	350 V~
T1	Impulse discharge current (Iimp, 10/350)	L-N	25 kA
		N-PE	100 kA
		L-PE	25 kA
	Total discharge current (L+N)/PE (Itotal, 10/350)		100 kA
T1	Protection level at Iimp (Up)	L-N	≤1.5 kV
		N-PE	≤1.5 kV
		L-PE	≤2.5 kV
T2	Nominal current In (8/20)	L-N	25 kA
		N-PE	100 kA
		L-PE	25 kA
Imax (8/20)		L-N/N-PE/L-PE	50/100/50 kA
Temporary overvoltages (LV supply faults) (TOV)		440 V/2 hrs (withstand mode)	
Temporary overvoltages (HV supply faults) (TOV)		1200 V (withstand mode)	
Protective device to be used : circuit breakers, fuses		See 3.4.2	
Short-circuit current withstand (Iscrr, Isc)		50 kA/350V~ and 100 kA/264V~	
Follow current (Ifi)		(L-N = 50 kA / N-PE = 100 A)/350 V~ e 100 kA/264 V~	
Residual current at Uc (Ipe)		0 A	
Max. line current (I _l)		125 A	
Voltage drop at I _l		< 1%	
Response time (T _A)		≤100 ns	
Terminal capacity		See 5.3	
Auxiliary contact for remote monitoring of SPD status		Yes	
		250 V~ - 1A - 1.5 mm ² max (125 V/1A DC)	
Pollution level		2	
Number of ports		1	
Location category		Indoor	
Installation method		Permanent	
Width (number of modules)		8	
Protection index		IP 20	
Operating temperature		-40°C to +80°C	
Storage temperature		-40°C to +80°C	





SPDs T1+T2 - 1P

Cat. Nos.		F10VX1
Number of poles		1P
Type of SPD		T1+T2/35 kA
Mains supply		400 V~
Maximum supply fluctuation		10%
Frequency		50/60 Hz
Earthing system		TT, TNS, TNC, IT
Protection modes		L(N)-PE
Max. continuous operating voltage (Uc)		440 V~
T1	Impulse discharge current (Iimp, 10/350)	L(N)-PE 35 kA
	Total discharge current (L+N)/PE (Itotal, 10/350)	35 kA
	Protection level at Iimp	L(N)-PE ≤2.5 kV
T2	Nominal current In (8/20)	L(N)-PE 35 kA
	I _{max} (8/20)	L(N)-PE 50 kA
Temporary overvoltages (LV supply faults) (TOV)		800 V~/2 hrs (withstand mode)
Temporary overvoltages (HV supply faults) (TOV)		1640 V/200 ms (failure mode)
Protective device to be used		See 3.4.2
Short-circuit current withstand (I _{sc} , I _{sc})		50 kA / 440 V~
Follow current (I _{fi})		50 kA / 440 V~
Residual current at U _c (I _{pe})		0 A
Max. line current (I _l)		125 A
Voltage drop at I _l		< 1%
Response time (T _A)		≤100 ns
Terminal capacity		See 5.3
Auxiliary contact for remote monitoring of SPD status		Yes 250 V~ - 1A - 1.5 mm ² max (125 V/1A DC)
Pollution level		2
Number of ports		1
Location category		Indoor
Installation method		Permanent
Width (number of modules)		2
Protection index		IP 20
Operating temperature		-40°C to +80°C
Storage temperature		-40°C to +80°C

 IT 230/400 V~ → use Cat. No. F10VX1 (Uc 440 V~)

3.4.2 Overcurrent Protective devices used with SPDs

P2	Megatiker M1 160-80 A	
		(gG)
*	P1 ≤ 250 A	P2 ≤ 125 A (P2 < P1)
	P1 > 250 A	I _{cc} ≤ 6 kA P2 = 125 A
		I _{cc} > 6 kA P2 = 250 A
(*) Fuse with striker or with indicator light		

P2	Type of SPD			
	2x 1P	3x 1P	3P+N	4x 1P
TT or TNS		-	3P (TNC)	4P or 3P+N
		2P or 1P+N		
IT(+N)		-	3P (IT)	-
		2P		4P

N conductor may not be cut or protected if allowed by local national rules. At minima, cut of neutral conductor recommended for purposes of easy maintenance and easy controls of the insulation resistance of the installation.

Two-phase mains supplies: 2P fuses only (ratings: see above)

4. CONFORMITY

Conforming to standards EN 61643-11:2012 and IEC 61643-11 edition 1: 2011.
These SPDs ensure compliance with the installation obligations and recommendations of standards CEI 64-8 (HD/IEC 60364) part 534, standards IEC/EN 62305 and guide UTE C 15-443 (TS/IEC 61643-12).

Conforming to directives 73/23/EC + 93/68/EC.

5. MOUNTING

5.1 General principle

Surge protective devices must not be installed in locations where there is a risk of fire or explosion without special provisions. They must be disconnected before checking the insulation resistance of the installation.

5.2 Types of SPD and earthing systems

Residual current devices and continuity of service: if the main distribution board protective device located upstream of the SPD includes a residual current device, this must be type S or delayed at the installation source (residual current device immunised against overvoltages up to 3 kA in accordance with CEI 64-8 and HD/IEC 60364). Also recommended for secondary distribution boards.

When possible (according to local rules), the SPD device should be installed upstream of the main protective device as shown below (in accordance with standards HD/IEC 60364).

SPDs and TT earthing system

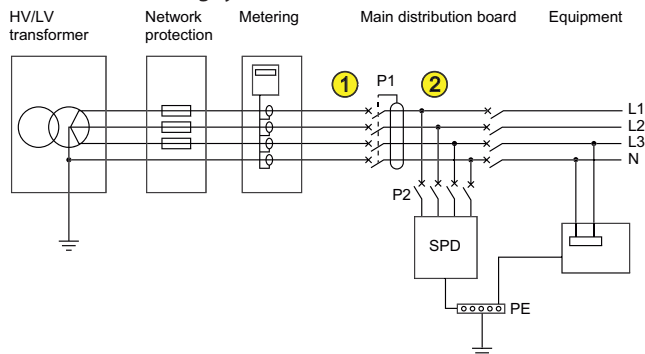

P1: main protective device of the installation

P2: protective device used with the SPD (see 3.4.2).

SPD: surge protective device with U_c 275 or 320 V recommended

① (upstream of P1): SPDs 1P+N/3P+N only

SPDs 1P/2P/3P/4P must always be installed downstream of a residual current device (discriminating or delayed, at the origin of the installation).

② (downstream of P1): any SPD

SPDs and TN (TNC, TNS and TNC-S) earthing systems

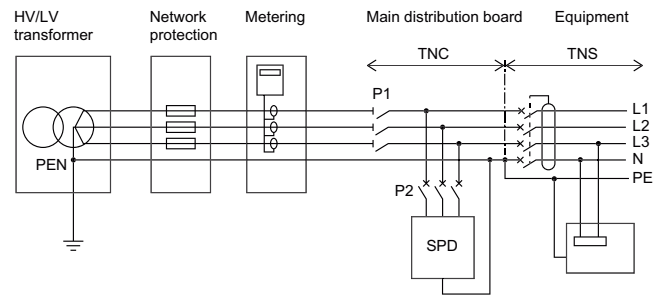

P1: main protective device of the installation

P2: protective device used with the SPD (see 3.4.2)

SPD: surge protective device with U_c 275 or 320 V recommended

SPDs and IT earthing system (230/400 V~)

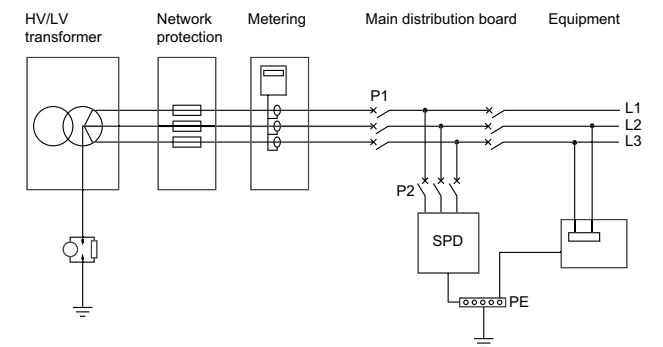

P1: main protective device of the installation

P2: protective device used with the SPD (see 3.4.2)

SPD: surge protective device with U_c 440 V (**$U_c < 440$ V prohibited**)

5.3 Connections

Check that the earth connection to which the exposed conductive parts of the installation are connected complies with standard CEI 64-8 (HD/IEC 60364).

SPD connected to the mains supply and to the protective conductor (PE) using as short a connection as possible, $X+Z \leq 50$ cm recommended.

Compulsory connection of the earth terminal on the surge protective device to the protective conductor (PE) on the distribution board.

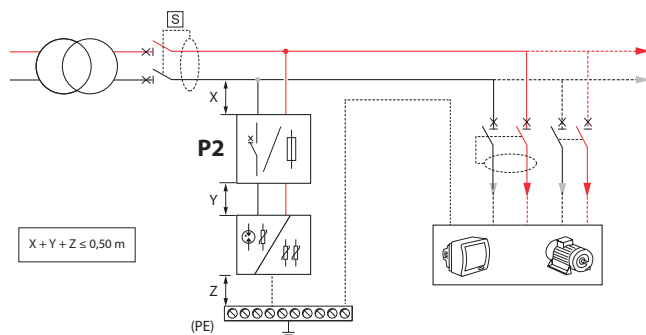

Equipotentiality rules: interconnection of the exposed conductive parts of the equipment and the protective conductor (PE) on the distribution board, which is itself connected to the earth terminal of the surge protective device.

Electromagnetic compatibility rules: avoid loops, fix the cables firmly against the exposed metal conductive parts.



P2 : Protective device used with the SPD (see 3.4.2)

Recommended connection cross-sections and lengths to be stripped :

		
F10VX1	16 - 35 mm ²	16 - 35 mm ²
F10T4	16 - 35 mm ²	16 - 25 mm ²

Tools required and tightening torque

- Flat blade screwdriver Ø 4 to 6.5 mm
- Crosshead screwdriver Ø 4 to 6.5 mm, Pozidriv PZ2 recess
- Recommended torque: 4,5 Nm

Reversibility

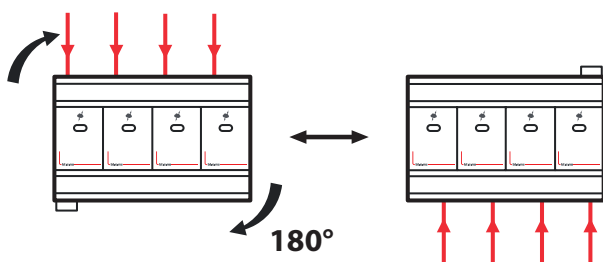

Series connection

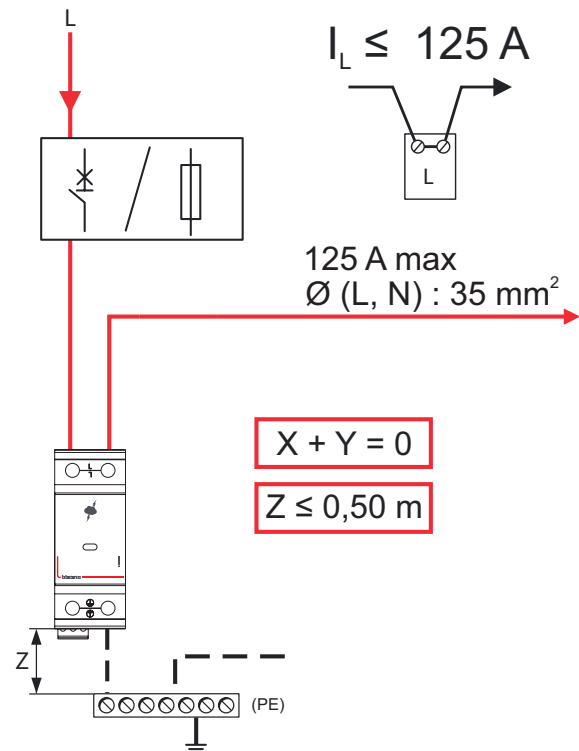

5.4 Cascaded SPDs

Effective protection against overvoltages cannot generally be assured with a single SPD if its protection level (U_p) is greater than 1.2 kV (EN/IEC 62305 and TS/IEC 61643-12).

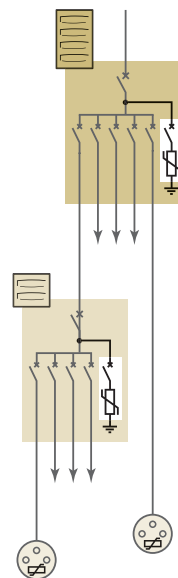

When there are overvoltages, an SPD protects equipment by limiting these overvoltages to values that can be tolerated by the equipment. Thus, depending on its discharge capacity (discharge current I_n , I_{max} , etc.) and its protection level (U_p), an SPD will limit these overvoltages to varying values depending on the energy levels involved. The overvoltage values likely to be transmitted downstream of the SPD can double over distances of more than 10 m due to resonances associated with the type of electrical installation and the type of equipment. Overvoltages greater than 2.5 kV can then occur and damage equipment if the residual energy is high enough (2.5 kV being the insulation level of most electrical and electronic equipment, or even 1.5 kV for electrical domestic appliances). SPDs should be installed in the distribution boards supplying equipment that is sensitive or critical for the activity being carried out (and/or near to equipment with proximity SPDs).

5.5 Coordinating upstream/downstream SPDs

Consists of ensuring that any downstream SPD (in distribution enclosures or proximity SPDs) is correctly coordinated in energy terms with any SPD located upstream (TS 61643-12).

Minimum distances between SPDs (meters)

Upstream SPD	Downstream SPD	With LPS ^(*)	Without LPS ^(*)
		Min. distance	Min. distance
T1+T2/35 and T1+T2/25	T2/40 (Uc 440V)	0	0
	T2/40 (Uc 320V)	1	0
T1/12,5 and T1+T2/8	T2/40	5	0
	T2/20 or T2/12	8	0
T2/40	T2/20 or T2/12	-	1
T2/20	T2/12	-	0,5
T2/20 and T2/12	Proximity SPD	-	2

(*) LPS : Lightning Protection System

6. ACCESSORIES

6.1 Signalling auxiliary

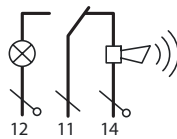
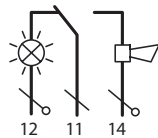
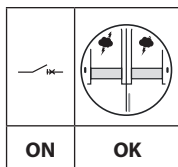
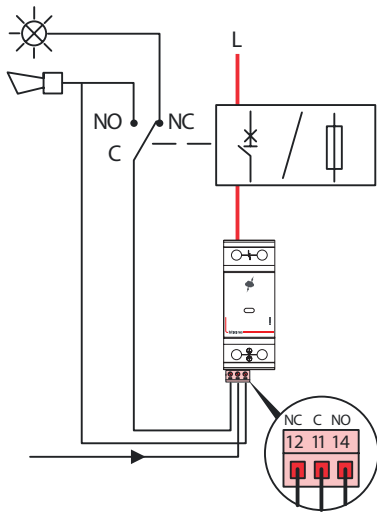

6.2 Replacement plug-in modules with status indicator

- Green : SPD operational
- Red : plug-in module needs to be replaced

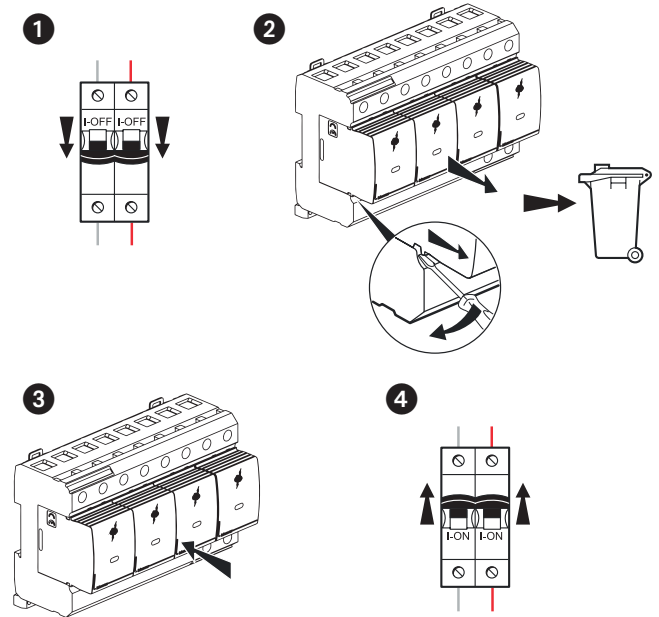
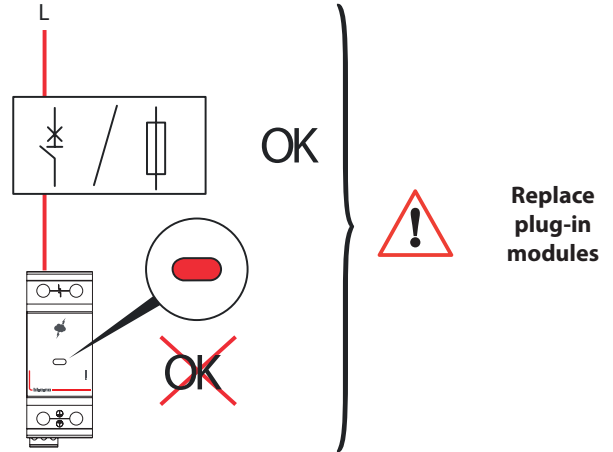

	F10VX1	F10T4	
	F10VXS	L-N : F10TS	N-PE : F10TNS