

**2 digital inputs / 2 relay outputs module
for F4N400**Cat. N°
F4N102

Contents	Pages
1. Description - Use	2
2. Range.....	2
3. Overall dimensions	2
4. Preparation - Connection	2
5. General characteristics	3
6. Compliance and approvals	5

2 digital inputs / 2 relay outputs module for F4N400

Cat. N°
F4N102

1. DESCRIPTION - USE

2 digital inputs / 2 relay outputs module.
Allows the monitoring of electrical quantities through two alarms; it allows also to display the status (open/closed), to count inputs and to count the energy on 2 tariffs, by 2 voltage-free inputs.
Each module is equipped with two independent inputs and two independent relay outputs

2. RANGE

. Cat. N° F4N102: 2 digital inputs / 2 relay outputs module; associable only to multifunction measuring device F4N400.
. It is possible to connect a maximum of two modules F4N102 obtaining 4 inputs / 4 relay outputs.

Auxiliary supply:

. Supplied by the multifunction measuring device F4N400

3. OVERALL DIMENSIONS

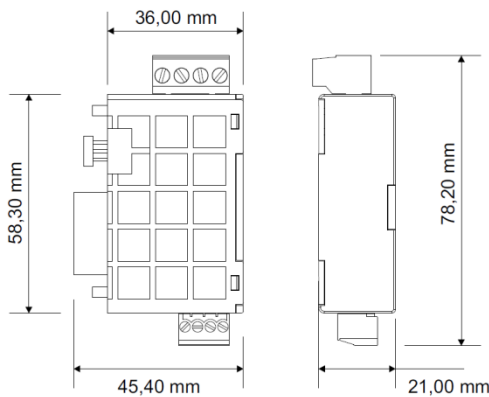

4. FIXING - CONNECTION

Fixing:

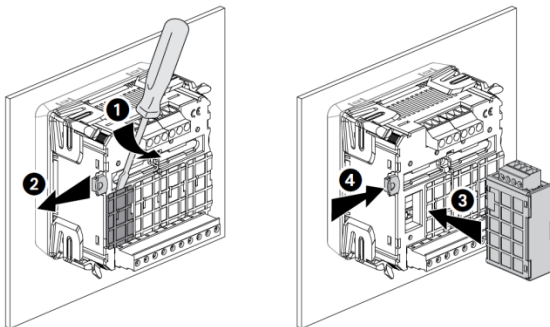

Note: modules must be connected with the device F4N400 not supplied.

4. FIXING - CONNECTION (continued)

Associability table:

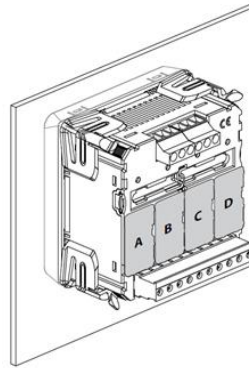

	A	B	C	D	
F4N101	×	×	✓	✓	max. 2
F4N102	×	×	✓	✓	max. 2
F4N103	✓	✓	✓	✓	max. 2
F4N104	✓	×	×	×	max. 1
F4N105	✓	×	×	×	max. 1
F4N106	×	×	×	✓	max. 1
F4N107	×	✓	×	×	max. 1

Operating position:

. Vertical Horizontal Upside down On the side

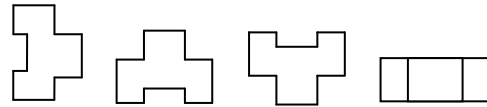

Screw terminals:

. Terminal depth: 8 mm.
. Stripping length: 8 mm

Screw head:

. Screw slotted.

Recommended tightening torque:

. 0,6 Nm.

Tools required:

. For inputs terminals: flat screwdriver 2,5 mm
. For outputs terminals: flat screwdriver 3,5 mm
. For fixing the modules to the measuring device: flat screwdriver max. 5 mm.

Connectable section:

. Copper cables.
. Outputs terminals (6-7, 8-9)

	Without ferrule	With ferrule
Rigid cable	0,05 a 4,5 mm ²	-
Flexible cable	0,05 a 2,5 mm ²	0,05 a 2,5 mm ²

. Inputs terminals (15-16, 17-18)

	Without ferrule	With ferrule
Rigid cable	0,05 a 2,5 mm ²	-
Flexible cable	0,05 a 1,5 mm ²	0,05 a 1,5 mm ²

2 digital inputs / 2 relay outputs module for F4N400

Cat. N°
F4N102

4. FIXING - CONNECTION (continued)

Wiring diagrams:

- Terminals identifications

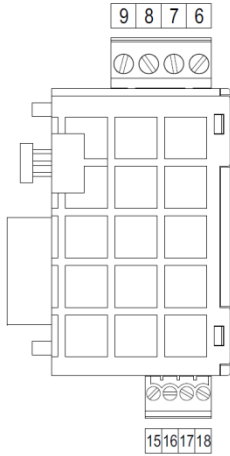

- Wirings:

Inputs

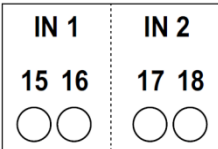

Outputs

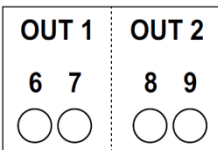

5. GENERAL CHARACTERISTICS

Terminals marking:

- By permanent ink pad printing.
- Outputs terminal

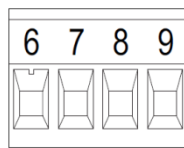
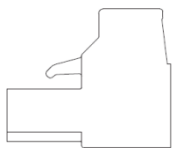

- Inputs terminal

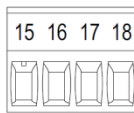
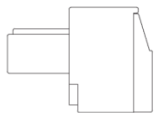

5. GENERAL CHARACTERISTICS (continued)

Digital inputs

- 2 voltage-free digital inputs SPST
- Features:
 - display of the input status (open/closed)
 - switching energy count on 2 tariffs (only input 15-16 of the module installed in the slot "C" - see § 4)
 - input pulse counting
- 4 input terminals - 2 independent inputs
- Input wiring:

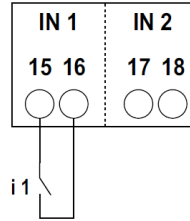

i: voltage-free input

Alarms output characteristics:

- Potential-free SPST-NO contact relay
- Voltage and Current:
 - max. 250 Va.c., 5 A @ $\cos\phi 1$, 3 A @ $\cos\phi 0,4$
 - max. 30 Vd.c., 5A
- Associable variables:
 - phase voltages, V_{1N} , V_{2N} , V_{3N}
 - chained voltages, U_{12} , U_{23} , U_{31}
 - phase currents, I_1 , I_2 , I_3
 - average current
 - frequency, f
 - three-phase active power (positive or negative), P
 - phase active powers (positive or negative), P_1 , P_2 , P_3
 - three-phase reactive power (positive or negative), Q
 - phase reactive powers (positive or negative), Q_1 , Q_2 , Q_3
 - active power - average value
 - reactive power - average value
 - lagging (PF_L) or capacitive (PF_C) power factor
 - temperature (T_1 , T_2) from external probe (with module F4N106)
- Programmable intervention threshold
- Alarm type: high or low threshold
- Relay run mode: normally open (NO) / normally closed (NC)
- Hysteresis: 0÷20%
- Intervention delay: 0÷99 sec.
- Recovery delay: 0÷99 sec.

Output characteristics - Remote control via RS485:

- Potential-free SPST-NO contact relay
- Voltage and Current:
 - max. 250 Va.c., 5 A @ $\cos\phi 1$, 3 A @ $\cos\phi 0,4$
 - max. 30 Vd.c., 5A
- Control type:
 - bistable (rMtb)
 - temporized (rMtt)
- Relay run mode: normally open (NO) / normally closed (NC)
- Relay closing time: 0÷99 sec.

5. GENERAL CHARACTERISTICS *(continued)*

Plastic material:

. Self-extinguishing polycarbonate.

Ambient operating temperature:

. Min. = - 5 °C Max. = + 55 °C.

Ambient storage temperature:

. Min. = - 25 °C Max. = + 70 °C.

Impulse withstand voltage:

. Supply / Out 1 - Out 2:

alternate current 50 Hz / 1 min.: 2 kV

. Measuring inputs / Out 1 - Out 2:

alternate current 50 Hz / 1 min.: 2 kV

. Supply / Input 1 - Input 2:

alternate current 50 Hz / 1 min.: 2 kV

. Measuring inputs / Input 1 - Input 2:

alternate current 50 Hz / 1 min.: 2 kV

Note: values referred to combination measuring device + add-on module.

Average weight per device:

. 0,040 kg.

Volume when packed:

. 0,30 dm³

Consumption:

. Module F4N102: ≤ 1 VA

. Measuring device F4N400 + 1 Module F4N102: ≤ 5 VA

. Measuring device F4N400 + 2 Modules F4N102: ≤ 6 VA

6. COMPLIANCE AND APPROVALS

Compliance to standards:

. Compliance with Directive on electromagnetic compatibility (EMC) n° 2004/108/EC

. Compliance with low voltage directive no. 73/23/CEE dated 19 February 1973, modified by directive no. 93/68/CEE dated 22 July 1993, modified by directive n° 2006/95/CE.