

Control/actuator

0 675 56 - AM5851M2 - H4671M2 - LN4671M2

Description

This device, with 4 pushbuttons and 4 two-colour LEDs at the front, is fitted with 2 independent relays to control:

- 2 loads or 2 groups of loads that are independent;
- 1 single load (rolling shutter motor).



The actuator may also be configured for the management of the connected load, whilst at the same time operating as a "control device" for the management of one or more remote actuators, with operating modes typical of a 2-module basic control.

More specifically, after the configuration, it is possible to set the following modes of operation:

1. Actuator for single load (lighting or shutter automation) with local control.
2. Actuator for 2 independent loads (lighting) with 2 local controls.
3. Actuator for 1 load (lighting) with local control by the left button and remote actuator or scenario control by the right button.
4. Actuator for 1 load (shutter automation) with local control by the left button and remote actuator or scenario control by the right button.

Technical data

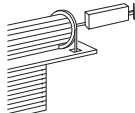
Power supply from BUS:	27 Vdc
Operating power supply with SCS BUS:	18 – 27 Vdc
Power consumption on standby:	14 mA max
Operating temperature:	0 – 40°C
Operating temperature:	(-5) – (+45) °C
Power/consumption of driven loads:	

Incandescent lamps - Halogen lamps 	Geared motors for rolling shutters 	LED lamps Compact fluorescent lamps 
230 Vac	460 W 2 A	460 W 2 A
70 W	Max. 2 lamps	

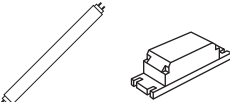
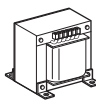
Linear fluorescent lamps - Electronic transformers 	Ferromagnetic transformers 
70 W	0,3 A
2 A cosφ 0,5	460 VA

Front

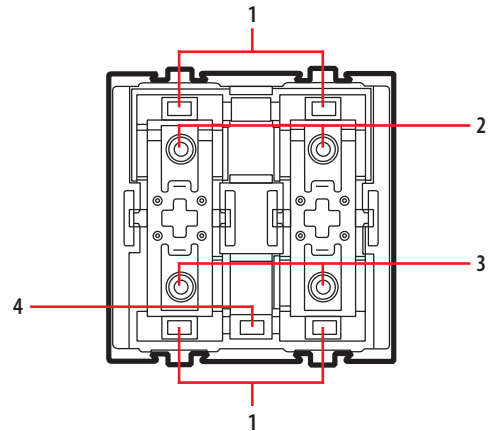

Rear

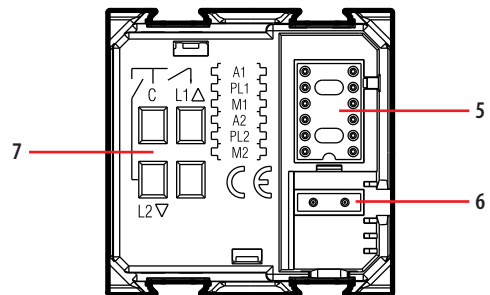

Legend

1. LED:
 - LIVING LIGHT: green with motor stopped, or orange (green + red) with motor in operation
green with light OFF, and orange with light ON
 - AXOLUTE: blue with motor stopped, or blue + red with motor in operation
blue with light OFF, or blue + red with light ON
2. Top buttons
3. Bottom buttons
4. LED control/off button
5. Configurator socket (note that this must only be used in MyHOME systems with the physical configuration)
6. BUS
7. Clamps (3 x 2.5 mm²) for connection to the load

Dimensions

Size: 2 flush-mounted modules

Configuration

If the device is installed in a MyHOME system it can be configured in two ways:

- PHYSICAL CONFIGURATION, inserting the configurators in position.
- Configuration via MyHOME_Suite software package, downloadable from www.homesystems-legrandgroup.com; this mode has the advantage of offering many more options than the physical configuration.

With the virtual configuration, the functions performed by the front buttons are independent of the functions of the local actuators.

The software lets you configure 4 independent addresses: 2 for the actuators and 2 for the front controls.

For a list of the procedures and their meanings, please refer to the instructions in this sheet and to the «Function Descriptions» help section in the MyHOME_Suite software package.

Note: For this device, the MyHOME Server automatically configures 2 channels.

Function selection

1. Lighting Actuator Mode (1 load) or shutter automation with local control

Configure A1, M1 and PL1 to define the local actuator address and mode.

1.1 Addressing

Address type		Virtual configuration (MyHOME_Suite)	Physical configuration
Apartment	Room	0-10	A1=0-9
	Lighting point	0-15	PL1=1-9

To configure the group address (1-10) from 0 to 255, use MyHOME_Suite virtual configuration.

1.2 Lighting

Virtual configuration (MyHOME_Suite)		Physical configuration	
Function	Parameter / setting		
Master Actuator - Cyclical ON/OFF	Master	M1=0	
ON with top button, OFF with bottom button	-	M1=0/1	
Actuator as Slave. Receives a control sent by a Master actuator with the same address	Slave		
Pushbutton (ON monostable) ignores Room and General controls	Master PUL OFF Delay = 0	M1=PUL	
Master Actuator with OFF control delayed on the corresponding Slave actuator. ¹⁾	Master PUL OFF Delay = 1 - 255	M1=1	1 minute
		M1=2	2 minutes
		M1=3	3 minutes
		M1=4	4 minutes

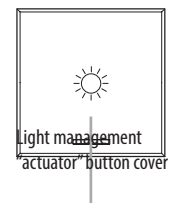

To define the type of load (lamp, solenoid valve, etc.), use MyHOME_Suite virtual configuration.

NOTE 1): Only for point-point control. With the OFF control the Master actuator deactivates; the Slave actuator deactivates after the time set on the Master actuator has elapsed. Typical function for use in bathrooms without windows where the ON control activates the light (Master actuator) and the ventilation fan (Slave actuator) at the same time. The OFF control switches the light off immediately and leaves the fan working for the time set with configurator 1 to 4 in M of the Master actuator as indicated in the table.

1.3 Automation

Virtual configuration (MyHOME_Suite)		Physical configuration	
Function	Parameter / setting		
Rolling shutter UP/DOWN with STOP after 2 minutes. The actuator ignores the Room and General controls	Master PUL	M1=OFF	
Rolling shutter UP/DOWN with STOP after the set time	Master, Slave	M1=5	1 minute
		M1=6	2 minutes
		M1=7	5 minutes
		M1=8	infinite
UP/DOWN monostable	-	M1= ↑↓M	
UP/DOWN bistable	-	M1= ↑↓	

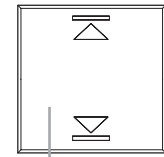

Copritasto "attuatore" gestione tapparella

To use the "Actuator as a slave with PUL function", the "Load Type" (Actuator, Rolling Shutter, Curtain, Gate, Rocker) and define the STOP time 1-60 sec., 2-10 min., use

MyHOME_Suite virtual configuration.

2. Lighting Actuator Mode (2 separate loads) with local controls

In this mode, the actuator manages two separate loads, connected to the contacts C-L1 and C-L2 of the two relays, locally controlled with both front buttons, right (load connected in

C-L2) and left (load connected in C-L1).

2.1 Addressing

Address type		Virtual configuration (MyHOME_Suite)	Physical configuration
Apartment	Room	0-10	A1, A2=0-9
	Lighting point	0-15	PL1, PL2=1-9

To configure the group address (1-10) from 0 to 255, use MyHOME_Suite virtual configuration.

2.2 Lighting

Virtual configuration (MyHOME_Suite)		Physical configuration	
Function	Parameter / setting		
Master Actuator - Cyclical ON/OFF	Master	M2=0	M1=CEN
ON with top button, OFF with bottom button	-	M2=0/1	M1=CEN
Actuator as Slave. Receives a control sent by a Master actuator with the same address	Slave	M2=SLA	M1=CEN
Pushbutton (ON monostable) ignores Room and General controls	Master PUL OFF Delay = 0	M2=PUL	M1=CEN
Master Actuator with OFF control delayed on the corresponding Slave actuator. ¹⁾	Master PUL OFF Delay = 1 - 255	M2=1	M1=CEN 1 minute
		M2=2	M1=CEN 2 minutes
		M2=3	M1=CEN 3 minutes
		M2=4	M1=CEN 4 minutes

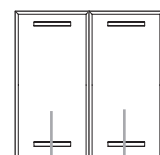

Lights 1 management "actuator" button cover

Lights 1 management "actuator" button cover

To define the type of load (lamp, solenoid valve, etc.), use MyHOME_Suite virtual configuration.

NOTE 1): Only for point-point control. With the OFF control the Master actuator deactivates; the Slave actuator deactivates after the time set on the Master actuator has elapsed. Typical function for use in bathrooms without windows where the ON control activates the light (Master actuator) and the ventilation fan (Slave actuator) at the same time. The OFF control switches the light off immediately and leaves the fan working for the time set with configurator 1 to 4 in M of the Master actuator as indicated in the table.

3. Actuator for 1 load (lighting) with local control by the left button and remote actuator or scenario control by the right button

3.1 Addressing

Configure A1, M1 and PL1 to define the local actuator address and mode of operation (controlled by the left button) as specified in paragraphs 1.1 and 1.2.

Configure A2 PL2 to define the address of the remote actuator to be managed, according to the following table:

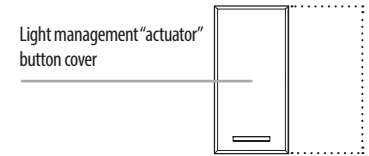

Address type		Virtual configuration (MyHOME_Suite)	Physical configuration
Point-to-point	Room	0-10	A2=1-9
	Lighting point	0-15	PL2=1-9
Room		0-10	A2=AMB, PL2=1-9
Group		1-255	A2=GR, PL2=1-9
General		General	A2=GEN

3.2 Mode of operation of the remote control

See chapter 5.

4. Actuator for 1 load (shutters automation) with local control by the left button and remote actuator or scenario control by the right button

4.1 Addressing

Configure A1, M1 and PL1 to define the local actuator address and mode of operation (controlled by the left button) as specified in paragraphs 1.1 and 1.3.

Configure A2 PL2 to define the address of the remote actuator to be managed, according to the following table:

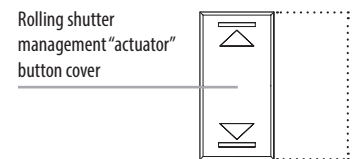

Address type		Virtual configuration (MyHOME_Suite)	Physical configuration
Point-to-point	Room	0-10	A2=1-9
	Lighting point	0-15	PL2=1-9
Room		0-10	A2=AMB, PL2=1-9
Group		1-255	A2=GR, PL2=1-9
General		General	A2=GEN

To configure the reference addresses for the Room and the Light Point of an actuator use MyHOME_Suite virtual configuration.

4.2 Mode of operation of the remote control

See chapter 5.

5. Mode of operation of the control by the right button

5.1 ON/OFF control

Virtual configuration (MyHOME_Suite)		Physical configuration
Function	Parameter / setting	
	Cyclic.	M2=0
	ON	M2=ON
	OFF	M2=OFF
	Button	M2=PUL
Timed ON	0.5sec	M2=8
	30sec	M2=7
	1min	M2=1
	2min	M2=2
	3min	M2=3
	4min	M2=4
	5min	M2=5
	15min	M2=6

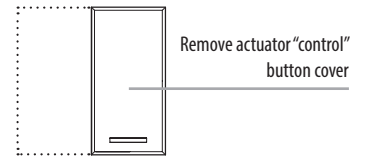

Or

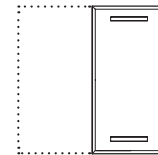

5.1.1 ON/OFF Control and ADJUSTMENT (Point-to-Point only):

Virtual configuration (MyHOME_Suite)	Physical configuration
Parameter / setting	
ON/OFF and cyclic ADJUSTMENT. ON/OFF when pressing briefly and adjustment when holding down.	M2=0
ON with top button, OFF with bottom button and DIMMER when held down	M2=0/1

For the "ON/OFF with adjustment" function, "Timed ON" with parameter 2sec, 10min, 15min, "Blinking", "Cyclic with custom point-to-point adjustment", "ON/OFF with custom

point-to-point adjustment", "Cyclic with custom adjustment" and "Custom cyclic dimmer with no adjustment" use virtual configuration via MyHOME_Suite

5.2 Automation

Virtual configuration (MyHOME_Suite)	Physical configuration
Parameter / setting	
Bistable control	M2=↑↓
Monostable control	M2=↑↓M

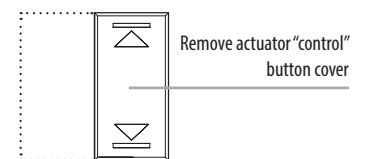

For bistable control + lath control use MyHOME_Suite virtual configuration

5.3 Programmed scenario activation

5.3.1 Addressing

Addressing type	Virtual configuration (MyHOME_Suite)	Physical configuration
Room	0-10	A2=1-9
Lighting point	0-15	PL2=1-9

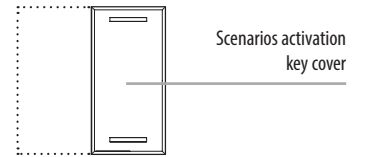

5.3.2 Mode

	Virtual configuration (MyHOME_Suite)	Physical configuration
Top button	0-31	M2=CEN
Bottom button	0-31	M2=CEN

The scenarios can only be activated with the button on the right. If the device is configured in PHYSICAL CONFIGURATION mode, the activated scenarios will be 1 and 2.

5.4 Plus programmed scenario activation

To configure the number 1 - 2047 of the scenario and of the buttons 0 - 31 on the control device, use MyHOME_Suite virtual configuration

Wiring diagrams

Wiring diagram for light connection

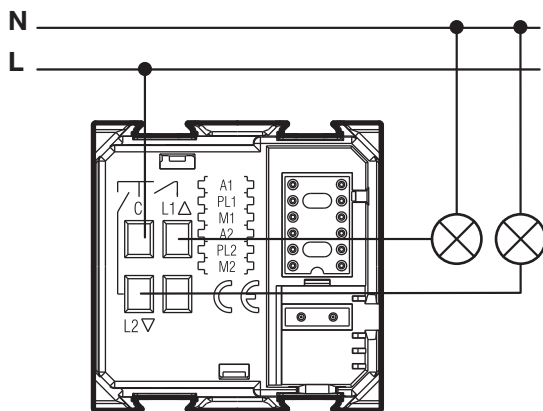

Wiring diagram for rolling shutter connection

