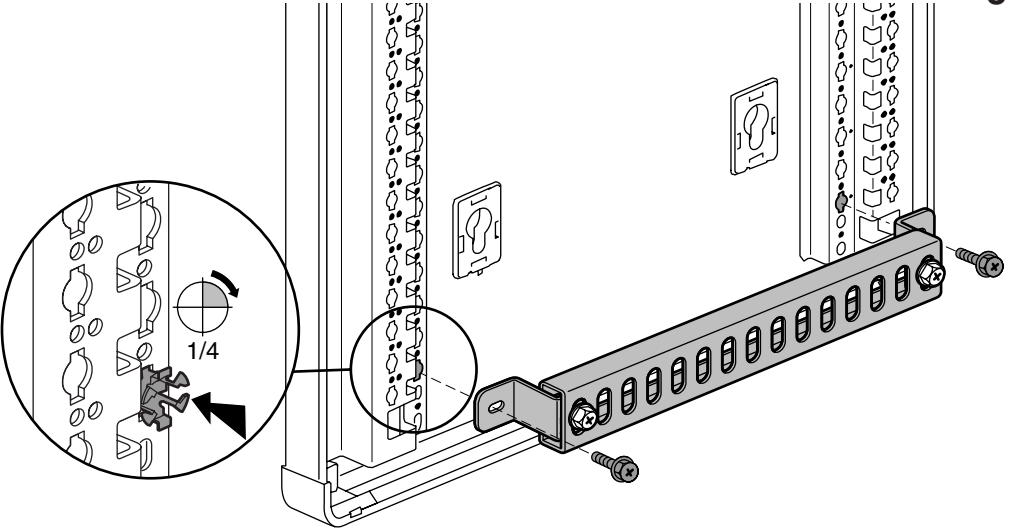

3**4**